

Controller LT-M3 Controller LT-RF28C-1 Controller LT-RF28C-2



1. Parameter:

Receiver:

- Compatible Remote: M1/M2/M3/M5/M6/M7
- Power Input: DC12V~DC24V
- Max Current Load: Max 3Ax3CH
- Max Output Power: 108W(12V)/216W(24V)
- Gray Scale Level: Max 4096x4096x4096
- Working Temp.: -30°C~55°C
- Dimensions: L135xW30xH20(mm)
- Weight(N.W.): 47g
- Total Weight(G.W.): 120g

Remote:

- Working Voltage: 3V (battery CR2032)
- Working Frequency: 433.92MHz
- Remote Distance: 40m~50m
- Working Temp.: -20°C~55°C
- Dimensions: L104xW58xH9(mm)
- Weight(N.W.): 42g

2. Feature:

- RF remote is fashionable, slim, light and easy to carry while receiver is small, exquisite and easy to install.
- RF remote with low power consumption, long distance, strong obstructions penetrating ability, independent ID interference-free and other properties.
- 4096/road grey scale (most of them is 256 in the market), high grayscale performance is more outstanding, the light is more gentle, dynamic changing modes become more rich and colorful.
- One receiver compatible with six different functions of the remote, that is use one receiver can experience dimming, color temperature and RGB control.
- RF remote is simple and intuitive to use, a variety of actions at a glance, what you see is what you get.
- Automatic sleep mode, when the touch remote unattended operation over 30s, it can automatically enter standby mode to extend battery life.

3. Product Size:

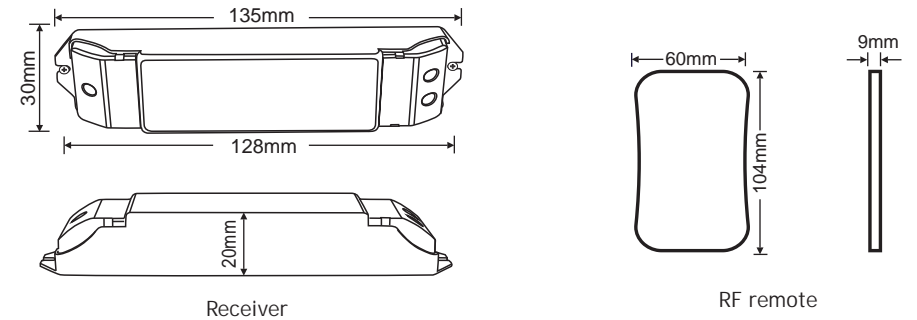

4. The Learning ID Method of Remote Control:

Remote control has been matched to the receiver before leave factory, if deleted accidentally, you can learn ID as follow.

Learning ID: Short press ID learning button on the receiver until the running light is on, then press any key on the remote control, the running light flashes several times, activated.

Cancel ID: Long press ID learning button on the receiver for 5 seconds.

Att: one receiver can be matched with max 10 same or different kinds remote.

5. Operating Instruction for Receiver :

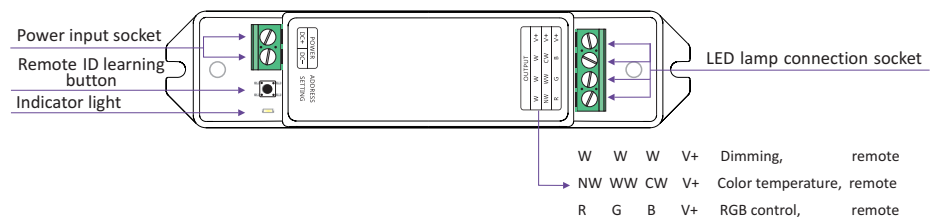

6. Operating Instruction for Remote Control :

sleep mode: when the touch remote unattended operation over 30s, it can automatically enter standby mode to extend battery life. press any of these four key to continue.

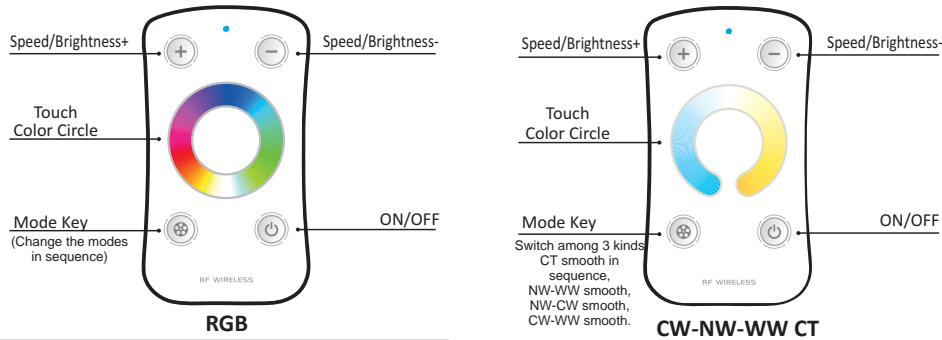
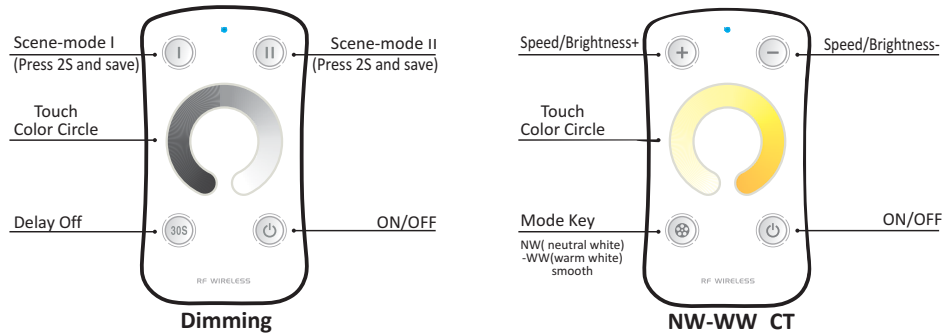

Tables of Changing Mode:		
1. Static Red	5. Static Purple	9. 7 Colors Skipping
2. Static Green	6. Static Cyan	10. RGB Color Smooth
3. Static Blue	7. Static White	11. Full-color Smooth
4. Static Yellow	8. RGB Skipping	

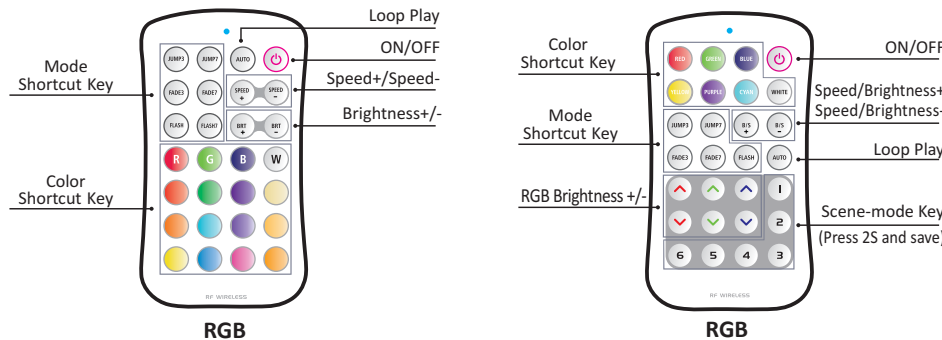

7. Wiring Diagram:

A. Dimming

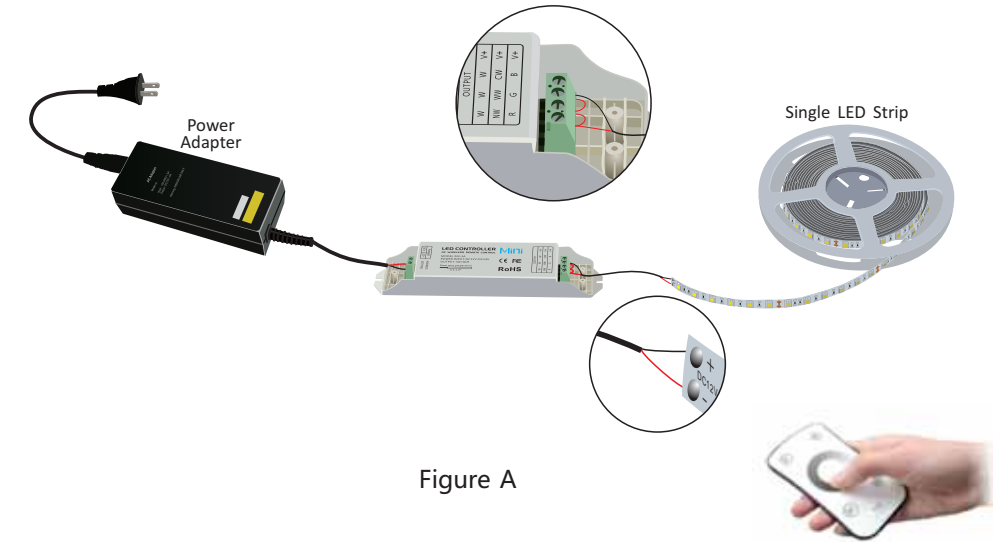

Figure A

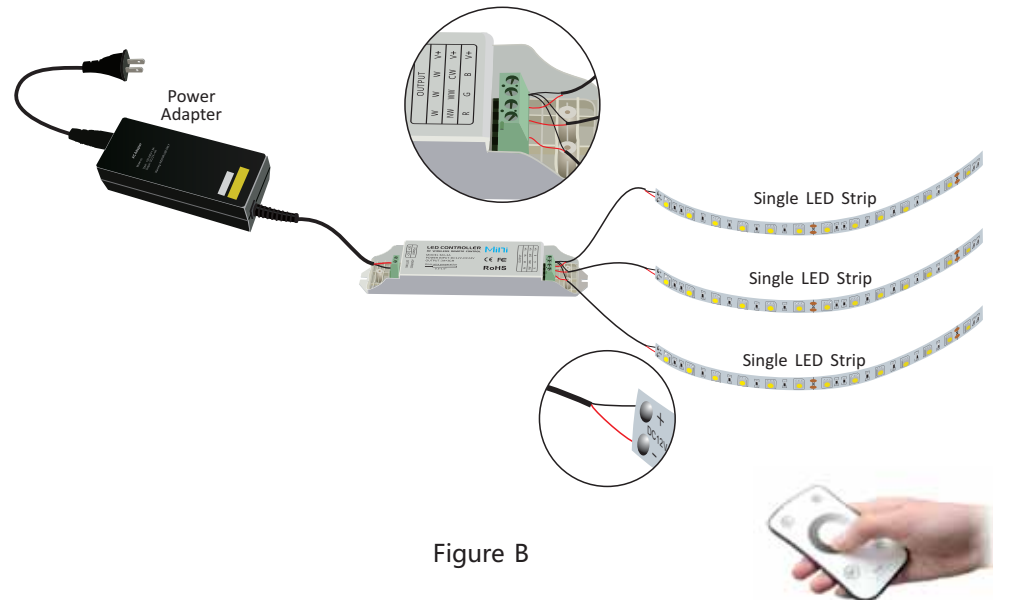
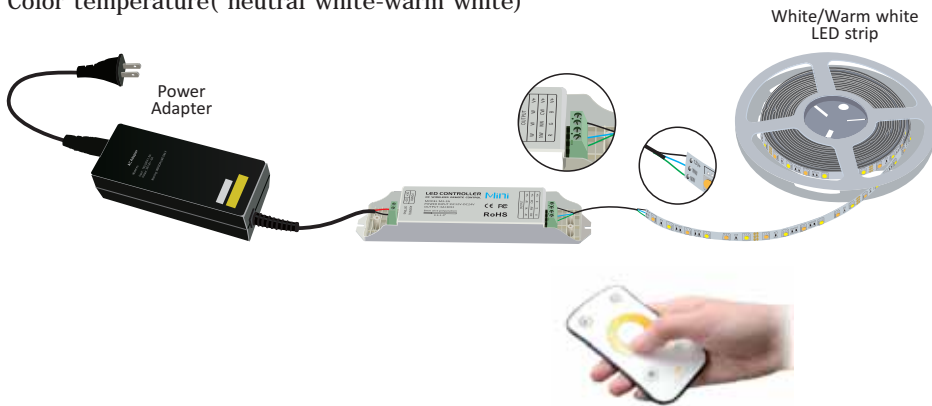
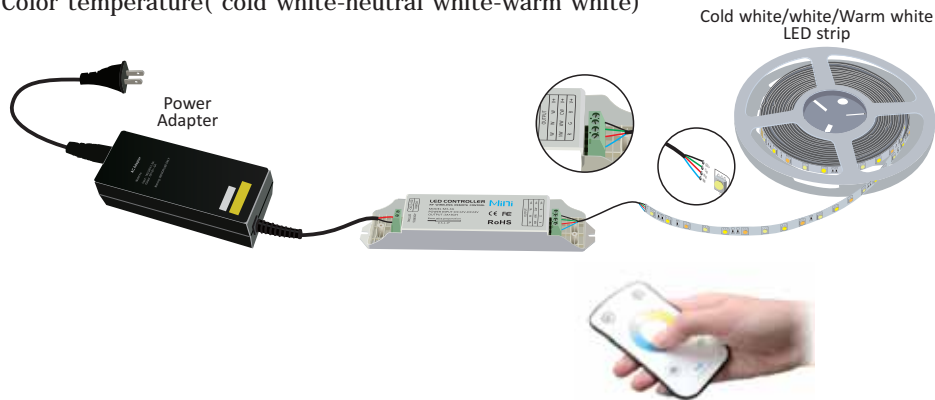

Figure B

B. Color temperature(neutral white-warm white)



C. Color temperature(cold white-neutral white-warm white)



D. RGB control



8. Attention:

1. The product shall be installed and serviced by a qualified person.
2. This product is non-waterproof. Please avoid the sun and rain. When installed outdoors please ensure it is mounted in a water proof enclosure.
3. Good heat dissipation will prolong the working life of the controller. Please ensure good ventilation.
4. Please check if the output voltage of any LED power supplies used comply with the working voltage of the product.
5. Please ensure that adequate sized cable is used from the controller to the LED lights to carry the current. Please also ensure that the cable is secured tightly in the connector.
6. Ensure all wire connections and polarities are correct before applying power to avoid any damages to the LED lights.
7. If a fault occurs please return the product to your supplier. Do not attempt to fix this product by yourself.