

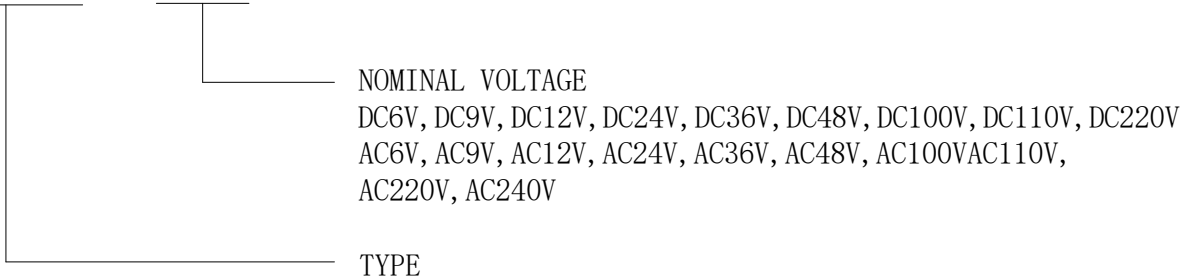

ORDERING CODE 订购代码

HLS-MK3P - DC12V



CONTACT DATA 触点参数:

Contact Form	触点形式	3C
Contact Material	触点材料	Ag Alloy
Contact Ratings	触点负载	10A 250VAC/280VDC
Max Switching Voltage	最大转换电压	250VAC/120VDC
Max Switching Current	最大转换电流	10A
Max Switching Power	最大转换功率	2500VA/280W
Initial Contact Resistance	接触电阻 (首次)	100mΩ Max at 6VDC 1A
Life Expectancy Electrical	电气寿命	100,000 Operations (rated load)
Life Expectancy Mechanical	机械寿命	10,000,000 Operations (no load)

GENERAL DATA 一般参数:

Insulation Resistance	绝缘阻值	500MΩ min at 500VDC	
Dielectric Strength Between Open Contacts	触点间耐压	1500VAC 50-60HZ (1 minute)	
Dielectric Strength Between Contacts And Coil	触点与线圈间耐压	1500VAC 50-60HZ (1 minute)	
Operate Time	吸合时间	30ms max	
Release Time	释放时间	20ms max	
Ambient Temperature	环境温度	-40°C to +55°C	
Shock Resistance 冲击	Malfunction	动作极限	10G
	Destruction	破坏极限	100G
Vibration Resistance	振动	10-55Hz, 1.5mm double amplitude	
Ambient humidity	湿度	35-85% RH	
Weight	重量	Approx 80g	
Safety Standard	安全标准		

COIL DATA 线圈参数: (@20°C)

Rated Voltage 额定电压 (V)	DC Coil 直流线圈			AC Coil 交流线圈		
	Coil Resistance Ω (±10%) 线圈阻值	Max Operate Voltage 最大吸合电压 (VDC)	Min Release Voltage 最小释放电压 (VDC)	Coil Resistance Ω (±10%) 线圈阻值	Max Operate Voltage 最大吸合电压 (VDC)	Min Release Voltage 最小释放电压 (VDC)

6	23.7	4.5	0.6	3.9	4.8	1.8
9	54	6.75	0.9	9	7.2	2.7
12	96	9	1.2	17	9.6	3.6
24	430	18	2.4	62.5	19.2	7.2
36	860	27	3.6	144	28.8	10.8
48	1640	36	4.8	305	38.4	14.4
110	7360	82.5	11	1250	88	33
220	29500	165	22	5170	176	66
240	-	-	-	6500	192	72

Outline Dimension 外形尺寸(mm)

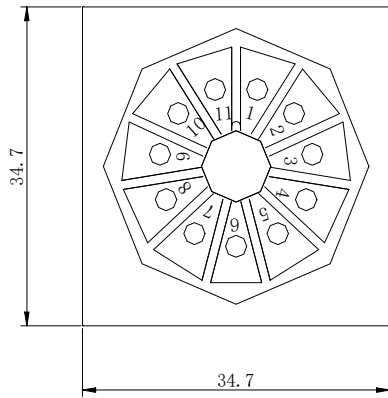

PC Board layout 安装图

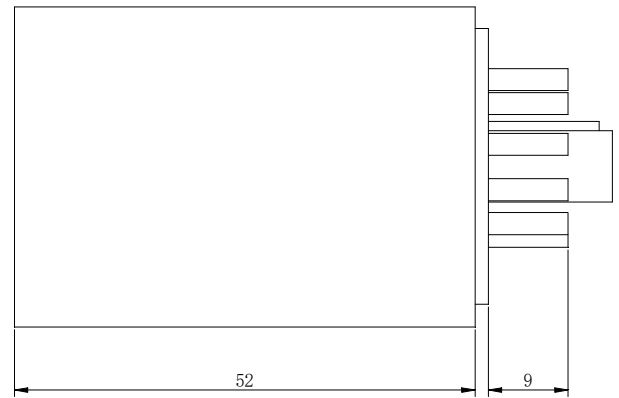

Wiring Diagram 接线图

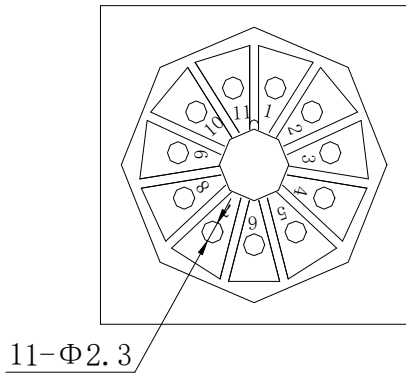

(Bottom View 底视)

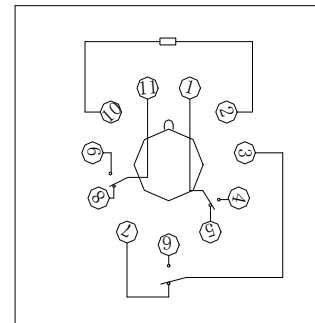

(Bottom View 底视)

声明：本产品规格书仅供客户使用时参考，若有更改，恕不另行通知。

对合力顺而言，不可能评定继电器在每个具体应用领域的所有性能参数要求，因而客户应该根据具体的使用条件选择与之相匹配的产品，若有疑问，请与合力顺联系获取更多技术支持。但产品选型责任仅由客户负责。

©宁波合力顺电子有限公司版权所有，本公司保留所有最终解释权。

Таблица возможной замены реле

силовые реле

HONGFA	TIANBO	SONGLE	HELISUN	OMRON
HF3FF	HJR-3FF	SRD(T73)	HLS8-T73	G5L
HF10FF-2			HLS-MK2P	MK2
HF10FF-3Z			HLS-MK3P	MK3
HF13F			HLS-13F	
HF18FF	HJQ-22		HLS-4453(18F)-4	MY4
HF21FF	HJR-21FF	SRU(22F)	HLS8-22F	G5L-E
HF32F	TRG1	SRSB	HLS-32F	835/835NL
HF32FA/32FA-T	TRG1	SRSB	HLS-32F	835/835NL
HF32FA-G	TRG1	SRSB	HLS-32F	835/835NL
HF33F	TRG2	SRSC	HLS-33F	G5SB
HF62F	TRA2F	SMIH(14FHA)	HLS-14FK	G5J
HF46F/HF46F-G	TRGB			202/202H
HF49FD				G5J
HF102F	TRAF		HLS-102F	G4A
HF115F	TRC2	SMIH(14FH)	HLS-14F2	G2RL
HF115FP	TRC3	SMIH(14FH)	HLS-14F3	
HF140FF	TRA3		HLS-14F	G2R/G2RG
HF13F	HJQ-13F-2C	SMB(13F)	HLS-13F-2	LY2
HF2100	HJQ-15F-1	SLC(T91)	HLS-T91(16F)-1	G7G
HF105F - 4	HJQ-15F-3	SLCH(T92)		
HF105F-1	HJQ-15F	SLA(T90)	HLS-T90(15F)	G8P
HF2160	HJQ-15F-2	SLI(T93)	HLS-T91(16F)-2	G7G/G8G
HF165FD	HJQ-15F	SLA	HLS-T90(15F)	G8P
JQC-21FF	HJR-21FF	SRD(T73)	HLS8-22F	
HF7FF	HJR-7FF	SRG(4123)	HLS8-T73	
HF141FF	TRA1		HLS-14F1	G2R
HF14FW	TRA2	SMIH(14FH)	HLS-14F2	G2R
HF14FF	TRA1		HLS-14F	G2R
HF36F	TRA4			
HF42F	TRA5			G5PA-2
HF8	TRDH	SRI(T72)	HLS-T72	
HF102F			HLS-102F	G4A
HLS-4453(18F)-2		SMBH(4453)	HLS-4453(18F)-2	MY2
HF18FF-3Z			HLS-4453(18F)-3	MY3

сигнальные реле

HONGFA	TIANBO	SONGLE	HELISUN	OMRON
HFD2	HJR1	SRC	HLS-4078	G5V-2
HFD4				
HFD27	HJR1-2	SRC	HLS-4078	G5V-2
HFD41	HJR4102	SRS		
HF41F			HLS6-4100H-1	G2E
HM4101F	HJR4102E			
HFD23			HLS6-23F	G5V-1

автомобильные реле

HONGFA	TIANBO	SONGLE	HELISUN	OMRON
HFKM, HFKS	TRAW	SLE(4117)	HLS-4117	
HVF6	TRFM			G8HN
HFKP	TRKP	SLB	HLS-4120	G8PE
	TRS			
	TRV3			
HFV4	TRV4	SLD	HLS-CMA3	G8JN
	TRV5			
HFV7	TRV6	SLDH	HLS-CMA3-1	G8JR
HFKW	HJR78F	SRA(T74)	HLS-T78	G8QN
			HLS-4121/4122	
HFV6		SLM	HLS-CMA6	G8H