

CS Series



Due to accurate wire winding technology, these chip inductors are designed for filtering, impedance matching, resonance and choke circuits for RF designer. Both standard series custom designs are available.

Features

- RoHS Compliant
- Ceramic body and wire wound construction provide high SRFs
- Exceptional Q values even at high frequencies
- Highest possible SRFs as well as excellent Q values
- The non-magnetic coil form assures utmost thermal stability, predictability and batch consistency
- CS series is standard for RF designers

Applications

- RF products for cellular phone
- GPS receiver
- Base Station
- Repeater
- Wireless LAN/ mouse/ keyboard/ earphone
- Remote control
- Security system and other RF modules

Product Identification

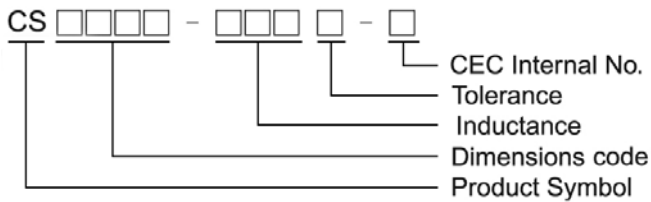

Shape and Dimensions / Recommended Pattern

CS0402

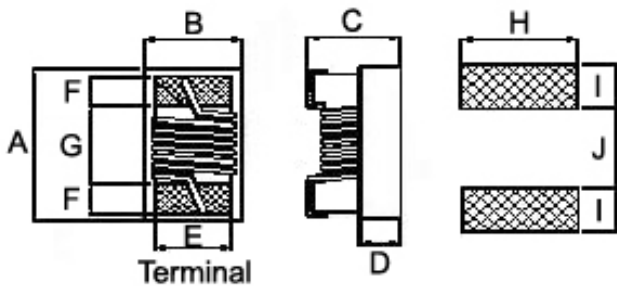

CS0603/0805/1008

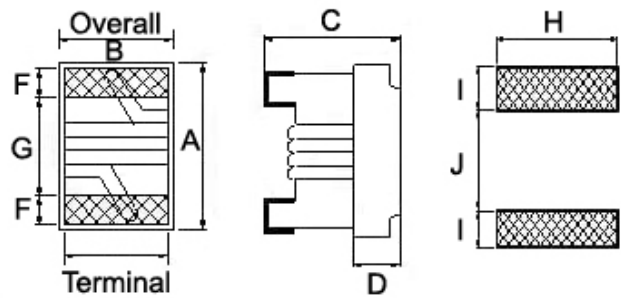

Dimensions

		A Max	B Max	C Max	D	E	F	G	H	I	J
CS0402	inch	0.047	0.028	0.026	0.010	0.020	0.009	0.022	0.026	0.014	0.018
	mm	1.19	0.70	0.66	0.25	0.51	0.23	0.56	0.66	0.36	0.46
CS0805	inch	0.093	0.068	0.06	0.028	0.050	0.020	0.040	0.070	0.040	0.030
	mm	2.35	1.73	1.52	0.71	1.27	0.51	1.02	1.78	1.02	0.76
CS1008	inch	0.115	0.110	0.083	0.046	0.080	0.020	0.060	0.100	0.040	0.050
	mm	2.92	2.79	2.1	1.16	2.03	0.51	1.52	2.54	1.02	1.27
		A	B	C	D	E	F	G	H	I	J
CS0603	mm	1.6 ^{+0.2} _{-0.1}	1.02±0.1	0.82 ^{+0.2} _{-0.1}	0.51	0.76	0.33	0.86	1.02	0.64	0.64

Electrical Characteristics

Part Number	Inductance (nH)	Test Frequency (MHz)	Tolerance (±%)	Q Min	SRF (GHz) Min	Rdc (Ω) Max	Irms (mA) Max
CS0402-1N0□-S	1.0	250	10 / 5 / ±0.1nH	16	12.7	0.045	1360
CS0402-1N2□-S	1.2	250	10 / 5 / ±0.1nH	10	10.0	0.140	640
CS0402-1N3□-S	1.3	250	10 / ±0.1nH	10	10.4	0.140	640
CS0402-1N9□-S	1.9	250	10 / 5 / ±0.1nH	16	11.3	0.070	1040
CS0402-2N0□-S	2.0	250	10 / 5 / ±0.1nH	16	11.1	0.070	1040
CS0402-2N2□-S	2.2	250	10 / 5 / ±0.1nH	19	10.8	0.070	960
CS0402-2N4□-S	2.4	250	10 / 5 / ±0.1nH	15	10.5	0.068	790
CS0402-2N5□-S	2.5	250	10 / 5 / ±0.1nH	13	10.4	0.150	640
CS0402-2N7□-S	2.7	250	10 / 5 / ±0.1nH	16	10.4	0.120	640
CS0402-3N3□-S	3.3	250	10 / 5 / 3	19	7.00	0.066	840
CS0402-3N6□-S	3.6	250	10 / 5 / 3	19	6.80	0.066	840
CS0402-3N9□-S	3.9	250	10 / 5 / 3	19	6.00	0.066	840
CS0402-4N3□-S	4.3	250	10 / 5 / 3	18	6.00	0.091	700
CS0402-4N7□-S	4.7	250	10 / 5 / 3	15	4.77	0.130	640
CS0402-5N1□-S	5.1	250	10 / 5 / 3	20	4.80	0.083	800
CS0402-5N6□-S	5.6	250	10 / 5 / 3	20	4.80	0.083	760
CS0402-6N2□-S	6.2	250	10 / 5 / 3	20	4.80	0.083	760
CS0402-6N8□-S	6.8	250	10 / 5 / 3	20	4.80	0.083	680
CS0402-7N3□-S	7.3	250	10 / 5 / 3	20	4.80	0.12	680
CS0402-7N5□-S	7.5	250	10 / 5 / 3	22	4.80	0.10	680
CS0402-8N2□-S	8.2	250	10 / 5 / 3	22	4.40	0.10	680
CS0402-8N7□-S	8.7	250	10 / 5 / 3	18	4.10	0.20	480
CS0402-9N0□-S	9.0	250	10 / 5 / 3	22	4.16	0.10	680
CS0402-9N1□-S	9.1	250	10 / 5 / 3	22	4.16	0.10	680
CS0402-9N5□-S	9.5	250	10 / 5 / 3	18	4.00	0.20	480
CS0402-10N□-S	10	250	10 / 5 / 3 / 2	21	3.90	0.20	480
CS0402-11N□-S	11	250	10 / 5 / 3 / 2	24	3.68	0.12	640
CS0402-12N□-S	12	250	10 / 5 / 3 / 2	24	3.60	0.12	640
CS0402-13N□-S	13	250	10 / 5 / 3 / 2	24	3.45	0.21	440
CS0402-15N□-S	15	250	10 / 5 / 3 / 2	24	3.28	0.17	560
CS0402-16N□-S	16	250	10 / 5 / 3 / 2	24	3.10	0.22	560
CS0402-18N□-S	18	250	10 / 5 / 3 / 2	25	3.10	0.23	420
CS0402-19N□-S	19	250	10 / 5 / 3 / 2	24	3.04	0.20	480
CS0402-20N□-S	20	250	10 / 5 / 3 / 2	25	3.00	0.25	420
CS0402-22N□-S	22	250	10 / 5 / 3 / 2	25	2.80	0.30	400
CS0402-23N□-S	23	250	10 / 5 / 3 / 2	22	2.72	0.30	400
CS0402-24N□-S	24	250	10 / 5 / 3 / 2	25	2.70	0.30	400
CS0402-27N□-S	27	250	10 / 5 / 3 / 2	24	2.48	0.30	400
CS0402-30N□-S	30	250	10 / 5 / 3 / 2	25	2.35	0.35	400

- When ordering, please specify tolerance and packaging codes.
- Tolerance : B = ±0.1uH , G = ±2% , H = ±3% , J = ±5% , K = ±10%
- L , Q : Agilent E4991A+AgilentHP16197A
- SRF : Agilent/HP8753D / Agilent/HP8722ES
- Rdc : HP4287A
- I rms for a 15°C rise above 25°C ambient.

Electrical Characteristics

Part Number	Inductance (nH)	Test Frequency (MHz)	Tolerance (±%)	Q Min	SRF (GHz) Min	Rdc (Ω) Max	Irms (mA) Max
CS0402-33N□-S	33	250	10 / 5 / 3 / 2	24	2.35	0.40	400
CS0402-36N□-S	36	250	10 / 5 / 3 / 2	24	2.32	0.44	320
CS0402-39N□-S	39	250	10 / 5 / 3 / 2	25	2.10	0.55	200
CS0402-40N□-S	40	250	10 / 5 / 3 / 2	24	2.24	0.65	320
CS0402-43N□-S	43	250	10 / 5 / 3 / 2	25	2.03	0.81	100
CS0402-47N□-S	47	250	10 / 5 / 3 / 2	20	2.10	0.83	150
CS0402-51N□-S	51	250	10 / 5 / 3 / 2	25	1.75	0.82	100
CS0402-56N□-S	56	250	10 / 5 / 3 / 2	22	1.76	0.97	100
CS0402-68N□-S	68	250	10 / 5 / 3 / 2	22	1.62	1.12	100
CS0402-82N□-S	82	250	10 / 5 / 3 / 2	20	1.26	1.55	50
CS0402-R10□-S	100	250	10 / 5 / 3 / 2	20	1.16	2.00	30
CS0402-R18□-S	180	100	10 / 5 / 3 / 2	8	0.70	2.70	50

- When ordering, please specify tolerance and packaging codes.
- Tolerance : B = ±0.1uH , G = ±2% , H = ±3% , J = ±5% , K = ±10%
- L , Q : Agilent E4991A+AgilentHP16197A
- SRF : Agilent/HP8753D / Agilent/HP8722ES
- Rdc : HP4287A
- Irms for a 15°C rise above 25°C ambient.

Electrical Characteristics

Part Number	Inductance (nH)	Test Frequency (MHz)	Tolerance (±%)	Q Min	SRF (MHz) Min	Rdc (Ω) Max	Irms (mA) Max	Color
CS0603-1N6□-S	1.6	250	10 / 5 / ±0.1nH	24	12500	0.030	700	Red
CS0603-1N8□-S	1.8	250	10 / 5 / ±0.1nH	16	12500	0.045	700	Black
CS0603-2N2□-S	2.2	250	10 / 5 / ±0.1nH	13	12500	0.250	700	Yellow
CS0603-3N3□-S	3.3	250	10 / 5 / 3	35	5900	0.045	700	Blue
CS0603-3N6□-S	3.6	250	10 / 5 / 3	22	5900	0.063	700	Red
CS0603-3N9□-S	3.9	250	10 / 5 / 3	22	6900	0.080	700	Brown
CS0603-4N3□-S	4.3	250	10 / 5 / 3	22	5900	0.063	700	Orange
CS0603-4N7□-S	4.7	250	10 / 5 / 3	20	5800	0.116	700	Violet
CS0603-5N1□-S	5.1	250	10 / 5 / 3	20	5700	0.140	700	Green
CS0603-5N6□-S	5.6	250	10 / 5 / 3	20	5800	0.170	700	Yellow
CS0603-6N3□-S	6.3	250	10 / 5 / 3	20	5700	0.140	700	White
CS0603-6N8□-S	6.8	250	10 / 5 / 3	27	5800	0.110	700	Red
CS0603-7N5□-S	7.5	250	10 / 5 / 3	28	4800	0.106	700	Brown
CS0603-8N2□-S	8.2	250	10 / 5 / 3	28	4700	0.109	700	White
CS0603-8N7□-S	8.7	250	10 / 5 / 3	28	4600	0.109	700	Yellow
CS0603-9N1□-S	9.1	250	10 / 5 / 3	28	4800	0.120	700	Violet
CS0603-9N5□-S	9.5	250	10 / 5 / 3	28	5400	0.135	700	Blue
CS0603-10N□-S	10	250	10 / 5 / 3 / 2	31	4800	0.130	700	Orange
CS0603-11N□-S	11	250	10 / 5 / 3 / 2	33	4000	0.086	700	Gray
CS0603-12N□-S	12	250	10 / 5 / 3 / 2	35	4000	0.130	700	Yellow
CS0603-13N□-S	13	250	10 / 5 / 3 / 2	30	4000	0.160	700	Black
CS0603-15N□-S	15	250	10 / 5 / 3 / 2	35	4000	0.170	700	Green
CS0603-16N□-S	16	250	10 / 5 / 3 / 2	34	3300	0.104	700	White
CS0603-18N□-S	18	250	10 / 5 / 3 / 2	35	3100	0.170	700	Blue
CS0603-20N□-S	20	250	10 / 5 / 3 / 2	38	3000	0.190	700	Red
CS0603-22N□-S	22	250	10 / 5 / 3 / 2	38	3000	0.190	700	Violet
CS0603-23N□-S	23	250	10 / 5 / 3 / 2		2850	0.190	700	Orange
CS0603-24N□-S	24	250	10 / 5 / 3 / 2	37	2650	0.135	700	Black
CS0603-27N□-S	27	250	10 / 5 / 3 / 2	40	2800	0.220	600	Gray
CS0603-30N□-S	30	250	10 / 5 / 3 / 2	37	2250	0.144	600	Brown
CS0603-33N□-S	33	250	10 / 5 / 3 / 2	40	2300	0.220	600	White
CS0603-36N□-S	36	250	10 / 5 / 3 / 2	38	2080	0.250	600	Red
CS0603-39N□-S	39	250	10 / 5 / 3 / 2	40	2200	0.250	600	Black
CS0603-43N□-S	43	250	10 / 5 / 3 / 2	39	2000	0.280	600	Orange
CS0603-47N□-S	47	200	10 / 5 / 3 / 2	38	2000	0.280	600	Brown
CS0603-51N□-S	51	200	10 / 5 / 3 / 2	38	1900	0.310	600	Brown
CS0603-56N□-S	56	200	10 / 5 / 3 / 2	38	1900	0.310	600	Red
CS0603-68N□-S	68	200	10 / 5 / 3 / 2	37	1700	0.340	600	Orange
CS0603-72N□-S	72	150	10 / 5 / 3 / 2	34	1700	0.490	400	Yellow
CS0603-82N□-S	82	150	10 / 5 / 3 / 2	34	1700	0.540	400	Green
CS0603-91N□-S	91	150	10 / 5 / 3 / 2	34	1400	0.580	400	Black

- When ordering, please specify tolerance and packaging codes.
- Tolerance : B = ±0.1nH , H = ±3% , G = ±2% , J = ±5% , K = ±10%
- Packaging: Clear tape and reel {standard}.
- L /Q: Agilent E4991A + AgilentHP16197A
- SRF: HP8753D/ HP4291A
- RDC: CH502BC/ HP4338B
- I rms for a 15°C rise above 25°C ambient.
- Operating temperature range from -40°C to 125°C. (Including self - temperature rise)

Electrical Characteristics

Part Number	Inductance (nH)	Test Frequency (MHz)	Tolerance (±%)	Q Min	SRF (MHz) Min	Rdc (Ω) Max	Irms (mA) Max	Color
CS0603-R10□-S	100	150	10 / 5 / 3 / 2	34	1400	0.580	400	Blue
CS0603-R11□-S	110	150	10 / 5 / 3 / 2	32	1350	0.610	300	Violet
CS0603-R12□-S	120	150	10 / 5 / 3 / 2	32	1300	0.750	300	Gray
CS0603-R15□-S	150	150	10 / 5 / 3 / 2	28	990	0.920	280	White
CS0603-R16□-S	160	100	10 / 5 / 3 / 2	25	990	1.250	240	Yellow
CS0603-R18□-S	180	100	10 / 5 / 3 / 2	25	990	1.250	240	Black
CS0603-R20□-S	200	100	10 / 5 / 3 / 2	25	900	2.100	200	Red
CS0603-R21□-S	210	100	10 / 5 / 3 / 2	27	895	2.060	200	Gray
CS0603-R22□-S	220	100	10 / 5 / 3 / 2	25	900	2.100	200	Brown
CS0603-R24□-S	240	100	10 / 5 / 3 / 2	25	900	2.200	200	Green
CS0603-R25□-S	250	100	10 / 5 / 3 / 2	25	822	3.550	120	Violet
CS0603-R27□-S	270	100	10 / 5 / 3 / 2	24	900	2.800	170	Red
CS0603-R33□-S	330	100	10 / 5 / 3 / 2	25	900	3.890	100	Orange
CS0603-R39□-S	390	100	10 / 5 / 3 / 2	25	900	4.350	100	Yellow
CS0603-R47□-S	470	100	10 / 5 / 3 / 2	25	500	4.500	100	Brown
CS0603-R56□-S	560	100	10 / 5 / 3 / 2	23	460	4.700	90	Blue

- When ordering, please specify tolerance and packaging codes.
- Tolerance : B = ±0.1nH , H = ±3% , G = ±2% , J = ±5% , K = ±10%
- Packaging: Clear tape and reel {standard}.
- L /Q: Agilent E4991A + AgilentHP16197A
- SRF: HP8753D/ HP4291A
- RDC: CH502BC/ HP4338B
- Irms for a 15°C rise above 25°C ambient.
- Operating temperature range from -40°C to 125°C. (Including self - temperature rise)

Electrical Characteristics

Part Number	Inductance (nH)	Test Frequency (MHz)	Tolerance (±%)	Q Min	Test Frequency (MHz)	SRF (MHz) Min	Rdc (Ω) Max	Irms (mA) Max	Color
CS0805-2N8□-S	2.8	250	10 / 5 / 2	80	1500	7900	0.06	800	Gray
CS0805-3N0□-S	3.0	250	10 / 5 / 2	65	1500	7900	0.06	800	White
CS0805-3N3□-S	3.3	250	10 / 5 / 2	50	1500	7900	0.08	600	Black
CS0805-5N6□-S	5.6	250	10 / 5 / 2	65	1000	5500	0.08	600	Orange
CS0805-6N8□-S	6.8	250	10 / 5 / 2	50	1000	5500	0.11	600	Brown
CS0805-7N5□-S	7.5	250	10 / 5 / 2	50	1000	4500	0.14	600	Green
CS0805-8N2□-S	8.2	250	10 / 5 / 2	50	1000	4700	0.12	600	Red
CS0805-10N□-S	10	250	10 / 5 / 2	60	500	4200	0.10	600	Blue
CS0805-12N□-S	12	250	10 / 5 / 2	50	500	4000	0.15	600	Orange
CS0805-15N□-S	15	250	10 / 5 / 2	50	500	3400	0.17	600	Yellow
CS0805-18N□-S	18	250	10 / 5 / 2	50	500	3300	0.20	600	Green
CS0805-22N□-S	22	250	10 / 5 / 2	55	500	2600	0.22	500	Blue
CS0805-24N□-S	24	250	10 / 5 / 2	50	500	2000	0.22	500	Gray
CS0805-27N□-S	27	250	10 / 5 / 2	55	500	2500	0.25	500	Violet
CS0805-33N□-S	33	250	10 / 5 / 2	60	500	2050	0.27	500	Gray
CS0805-36N□-S	36	250	10 / 5 / 2	55	500	1700	0.27	500	Orange
CS0805-39N□-S	39	250	10 / 5 / 2	60	500	2000	0.29	500	White
CS0805-43N□-S	43	200	10 / 5 / 2	60	500	1650	0.34	500	Yellow
CS0805-47N□-S	47	200	10 / 5 / 2	60	500	1650	0.31	500	Black
CS0805-56N□-S	56	200	10 / 5 / 2	60	500	1550	0.34	500	Brown
CS0805-68N□-S	68	200	10 / 5 / 2	60	500	1450	0.38	500	Red
CS0805-82N□-S	82	150	10 / 5 / 2	65	500	1300	0.42	400	Orange
CS0805-91N□-S	91	150	10 / 5 / 2	65	500	1200	0.48	400	Black
CS0805-R10□-S	100	150	10 / 5 / 2	65	500	1200	0.46	400	Yellow
CS0805-R11□-S	110	150	10 / 5 / 2	50	250	1000	0.48	400	Brown
CS0805-R12□-S	120	150	10 / 5 / 2	50	250	1100	0.51	400	Green
CS0805-R15□-S	150	100	10 / 5 / 2	50	250	920	0.56	400	Blue
CS0805-R18□-S	180	100	10 / 5 / 2	50	250	870	0.64	400	Violet
CS0805-R20□-S	200	100	10 / 5 / 2	50	250	860	0.68	400	Red
CS0805-R22□-S	220	100	10 / 5 / 2	50	250	850	0.70	400	Gray
CS0805-R24□-S	240	100	10 / 5 / 2	44	250	690	1.00	350	Red
CS0805-R25□-S	250	100	10 / 5 / 2	45	250	660	1.20	350	Yellow
CS0805-R27□-S	270	100	10 / 5 / 2	48	250	650	1.00	350	White
CS0805-R33□-S	330	100	10 / 5 / 2	48	250	600	1.40	310	Black
CS0805-R39□-S	390	100	10 / 5 / 2	48	250	560	1.50	290	Brown
CS0805-R47□-S	470	50	10 / 5 / 2	33	100	375	1.76	250	Violet
CS0805-R51□-S	510	25	10 / 5 / 2	23	50	340	1.90	230	Gray
CS0805-R56□-S	560	25	10 / 5 / 2	23	50	340	1.90	230	Orange
CS0805-R62□-S	620	25	10 / 5 / 2	23	50	220	2.20	210	Yellow
CS0805-R68□-S	680	25	10 / 5 / 2	23	50	188	2.20	190	Green
CS0805-R82□-S	820	25	10 / 5 / 2	23	50	215	2.35	180	Blue

- When ordering, please specify tolerance and packaging codes.
- Tolerance : G = ±2% , J = ±5% , K = ±10%
- L/Q: Agilent E4991A +AgilentHP16197A
- SRF: Agilent/HP8753D / Agilent/HP4291A
- RDC: CH502BC/ HP4338B
- Irms for a 15°C rise above 25°C ambient.
- Operating temperature range from -40°C to 125°C. (Including self - temperature rise)

Electrical Characteristics

Part Number	Inductance (nH)	Test Frequency (MHz)	Tolerance (±%)	Q Min	Test Frequency (MHz)	SRF (MHz) Min	Rdc (Ω) Max	Irms (mA) Max	Color
CS0805-1R0□-S	1000	25	10 / 5 / 2	20	50	100	2.50	170	Gray
CS0805-1R2□-S	1200	7.9	10 / 5	18	25	100	2.50	170	White
CS0805-1R8□-S	1800	7.9	10 / 5 / 2	16	7.9	80	2.50	170	Orange
CS0805-3R3□-S	3300	7.9	10 / 5 / 2	15	7.9	40	4.40	90	Red
CS0805-4R7□-S	4700	7.9	10 / 5 / 2	15	7.9	40	6.40	90	Yellow

- When ordering, please specify tolerance and packaging codes.
- Tolerance : G = ±2% , J = ±5% , K = ±10%
- L/Q: Agilent E4991A +AgilentHP16197A
- SRF: Agilent/HP8753D / Agilent/HP4291A
- RDC: CH502BC/ HP4338B
- I rms for a 15°C rise above 25°C ambient.
- Operating temperature range from -40°C to 125°C . (Including self - temperature rise)

Electrical Characteristics

Part Number	Inductance (nH)	Test Frequency (MHz)	Tolerance (±%)	Q Min	Test Frequency (MHz)	SRF (MHz) Min	Rdc (Ω) Max	Irms (mA) Max	Color Coding		
									1 ST	2 ND	3 RD
CS1008-10N□-S	10	50	10 / 5 / 2	50	500	4100	0.08	1000	Brown	Black	Black
CS1008-12N□-S	12	50	10 / 5 / 2	50	500	3300	0.09	1000	Brown	Red	Black
CS1008-15N□-S	15	50	10 / 5 / 2	50	500	2500	0.10	1000	Brown	Green	Black
CS1008-18N□-S	18	50	10 / 5 / 2	50	350	2500	0.11	1000	Brown	Gray	Black
CS1008-22N□-S	22	50	10 / 5 / 2	55	350	2400	0.12	1000	Red	Red	Black
CS1008-27N□-S	27	50	10 / 5 / 2	55	350	1600	0.13	1000	Red	Violet	Black
CS1008-33N□-S	33	50	10 / 5 / 2	60	350	1600	0.14	1000	Orange	Orange	Black
CS1008-39N□-S	39	50	10 / 5 / 2	60	350	1500	0.15	1000	Orange	White	Black
CS1008-47N□-S	47	50	10 / 5 / 2	65	350	1500	0.16	1000	Yellow	Violet	Black
CS1008-56N□-S	56	50	10 / 5 / 2	65	350	1300	0.18	1000	Green	Blue	Black
CS1008-68N□-S	68	50	10 / 5 / 2	65	350	1300	0.20	1000	Blue	Gray	Black
CS1008-82N□-S	82	50	10 / 5 / 2	60	350	1000	0.22	1000	Gray	Red	Black
CS1008-R10□-S	100	25	10 / 5 / 2	60	350	1000	0.56	650	Brown	Black	Brown
CS1008-R12□-S	120	25	10 / 5 / 2	60	350	950	0.63	650	Brown	Red	Brown
CS1008-R15□-S	150	25	10 / 5 / 2	45	100	850	0.70	580	Brown	Green	Brown
CS1008-R18□-S	180	25	10 / 5 / 2	45	100	750	0.77	620	Brown	Gray	Brown
CS1008-R20□-S	200	25	10 / 5 / 2	45	100	700	0.84	500	Red	Black	Brown
CS1008-R22□-S	220	25	10 / 5 / 2	45	100	700	0.84	500	Red	Red	Brown
CS1008-R27□-S	270	25	10 / 5 / 2	45	100	600	0.91	500	Red	Violet	Brown
CS1008-R33□-S	330	25	10 / 5 / 2	45	100	570	1.05	450	Orange	Orange	Brown
CS1008-R39□-S	390	25	10 / 5 / 2	45	100	500	1.12	470	Orange	White	Brown
CS1008-R47□-S	470	25	10 / 5 / 2	45	100	450	1.19	470	Yellow	Violet	Brown
CS1008-R56□-S	560	25	10 / 5 / 2	45	100	415	1.33	400	Green	Blue	Brown
CS1008-R62□-S	620	25	10 / 5 / 2	45	100	375	1.40	300	Blue	Red	Brown
CS1008-R68□-S	680	25	10 / 5 / 2	45	100	375	1.47	400	Blue	Gray	Brown
CS1008-R75□-S	750	25	10 / 5 / 2	45	100	360	1.54	360	Violet	Green	Brown
CS1008-R82□-S	820	25	10 / 5 / 2	45	100	350	1.61	400	Gray	Red	Brown
CS1008-R91□-S	910	25	10 / 5 / 2	35	50	320	1.68	380	White	Brown	Brown
CS1008-1R0□-S	1000	25	10 / 5 / 2	35	50	290	1.75	370	Brown	Black	Red
CS1008-1R2□-S	1200	7.9	10 / 5 / 2	35	50	250	2.0	310	Brown	Red	Red
CS1008-1R5□-S	1500	7.9	10 / 5 / 2	28	50	200	2.3	330	Brown	Green	Red
CS1008-1R8□-S	1800	7.9	10 / 5 / 2	28	50	160	2.6	300	Brown	Gray	Red
CS1008-2R2□-S	2200	7.9	10 / 5 / 2	28	50	160	2.8	280	Red	Red	Red
CS1008-2R7□-S	2700	7.9	10 / 5 / 2	22	25	140	3.2	290	Red	Violet	Red
CS1008-3R3□-S	3300	7.9	10 / 5 / 2	22	25	110	3.4	290	Orange	Orange	Red
CS1008-3R9□-S	3900	7.9	10 / 5 / 2	20	25	100	3.6	260	Orange	White	Red
CS1008-4R7□-S	4700	7.9	10 / 5 / 2	20	25	90	4.0	260	Yellow	Violet	Red
CS1008-5R6□-S	5600	7.9	10 / 5 / 2	18	7.9	45	4.0	240	Green	Blue	Red
CS1008-6R8□-S	6800	7.9	10 / 5 / 2	18	7.9	40	4.9	200	Blue	Gray	Red
CS1008-8R2□-S	8200	7.9	10 / 5 / 2	18	7.9	25	6.0	170	Gray	Red	Red
CS1008-100□-S	10000	2.52	10 / 5 / 2	18	7.9	25	8.0	150	Brown	Black	Orange
CS1008-150□-S	15000	2.52	10 / 5 / 2	15	7.9	20	11	100	Brown	Brown	Orange

- When ordering, please specify tolerance and packaging codes
- Tolerance : G = ±2% , J = ±5% , K = ±10%
- Packaging: Clear tape and reel {standard}
- L/Q: Agilent E4991A + AgilentHP16197A
- SRF: Agilent/HP8753D / Agilent/HP4291A
- RDC: CH502BC/ HP4338B
- I rms for a 15°C rise above 25°C ambient
- Operating temperature range from -40°C to 125°C . (Including self - temperature rise)
- Inductance would be correct Chilisin standard piece

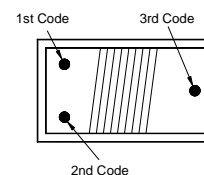

COLOR CODING



Packaging Specifications

Tape Dimensions

Figure 1

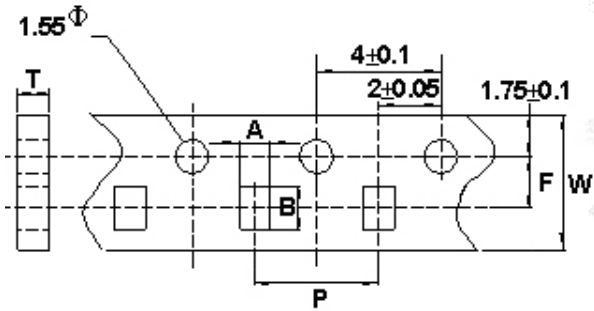

Tape Material

Carrier Tape: Polycarbonate
Cover Tape: Polystyrene

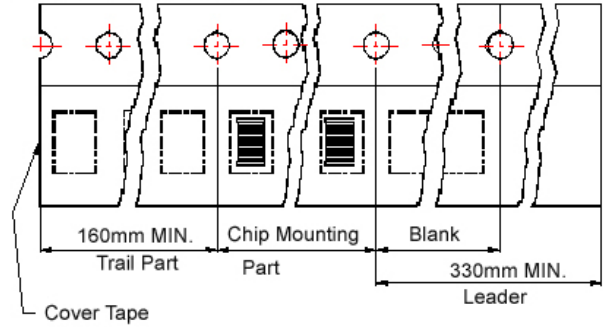
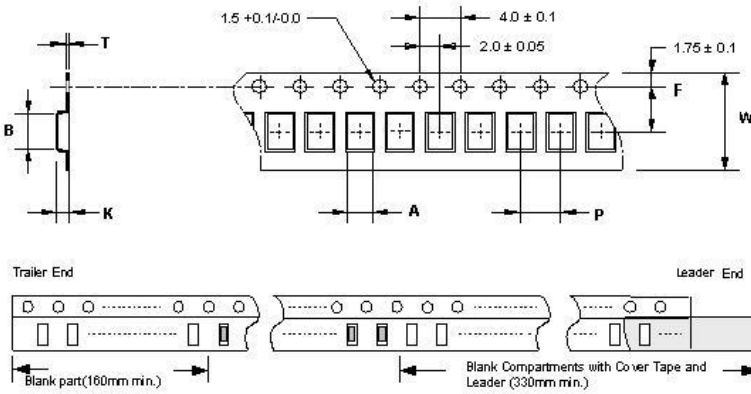
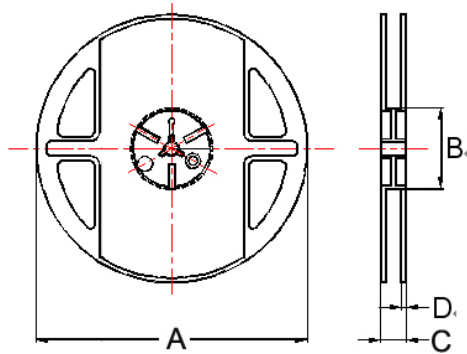

Figure 2



Reel Dimensions



Dimensions in mm

TYPE	Fig.	Tape Dimensions							Reel Dimensions				Quantity PCS / Reel
		A	B	T	W	P	F	K	A	B	C	D	
CS0402	2	0.67	1.20	0.75	8	2	3.5	0.53	178	60	12	1.5	4000
CS0603	1	1.20	1.80	0.97	8	4	3.5	-	178	60	12	1.5	4000
CS0805	2	1.85	2.45	0.23	8	4	3.5	1.50	178	60	12	1.5	2000
CS1008	2	2.80	2.95	0.23	8	4	3.5	2.20	178	60	12	1.5	2000