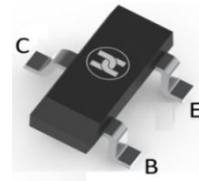
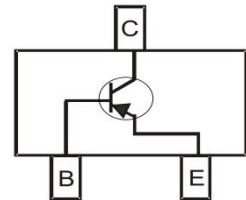

BIPOLAR TRANSISTOR (PNP)
FEATURES

- Complementary to MMBT4401
- Switching Transistor
- Surface Mount device

SOT-23
MECHANICAL DATA

- Case: SOT-23
- Case Material: Molded Plastic. UL flammability
- Classification Rating: 94V-0
- Moisture Sensitivity: Level 1 per J-STD-020
- Weight: 0.008 grams (approximate)

MAXIMUM RATINGS (T_A = 25°C unless otherwise noted)

Parameter	Symbol	Value	Unit
Collector-Base Voltage	V _{CB0}	-40	V
Collector-Emitter Voltage	V _{CEO}	-40	V
Emitter-Base Voltage	V _{EBO}	-5	V
Collector Current	I _C	-600	mA
Collector Power Dissipation	P _C	300	mW
Thermal Resistance From Junction To Ambient	R _{θJA}	417	°C/W
Junction Temperature	T _J	150	°C
Storage Temperature	T _{STG}	-55 ~+150	°C

ELECTRICAL CHARACTERISTICS (T_A = 25°C unless otherwise specified)

Parameter	Symbol	Min	Typ	Max	Unit	Conditions
Collector-base breakdown voltage	V _{(BR)CBO}	-40			V	I _C =-100μA, I _E =0
Collector-emitter breakdown voltage	V _{(BR)CEO}	-40			V	I _C =-1mA, I _B =0
Emitter-base breakdown voltage	V _{(BR)EBO}	-5			V	I _E =-100μA, I _C =0
Collector cut-off current	I _{CB0}			-0.1	μA	V _{CB} =-35V, I _E =0
Collector cut-off current	I _{CEx}			-0.1	μA	V _{CE} =-35V, V _{BE} =-0.4V
Emitter cut-off current	I _{EBO}			-0.1	μA	V _{EB} =-4V, I _C =0
DC current gain	h _{FE1}	30				V _{CE} =-1V, I _C =-0.1mA
	h _{FE2}	60				V _{CE} =-1V, I _C =-1mA
	h _{FE3}	100				V _{CE} =-1V, I _C =-10mA
	h _{FE4}	100		300		V _{CE} =-1V, I _C =-150mA
	h _{FE5}	20				V _{CE} =-2V, I _C =-500mA
Collector-emitter saturation voltage	V _{CE(sat)}			-0.4	V	I _C =-150mA, I _B =-15mA
	V _{CE(sat)}			-0.75	V	I _C =-500mA, I _B =-50mA
Base-emitter saturation voltage	V _{BE(sat)}			-0.95	V	I _C =-150mA, I _B =-15mA
	V _{BE(sat)}			-1.3	V	I _C =-500mA, I _B =-50mA
Transition frequency	f _T	200			MHz	V _{CE} =-10V, I _C =-20mA, f=100MHz
Delay time	t _d			15	ns	V _{CC} =-30V, V _{BE(OFF)} =-0.5V,
Rise time	t _r			20	ns	I _C =-150mA, I _{B1} =-15mA
Storage time	t _s			225	ns	V _{CC} =-30V, I _C =-150mA
Fall time	t _f			60	ns	I _{B1} =I _{B2} =-15mA

CLASSIFICATION OF h_{FE}

Range	100-300
Marking	2T

BIPOLAR TRANSISTOR (PNP)

Typical Characteristics

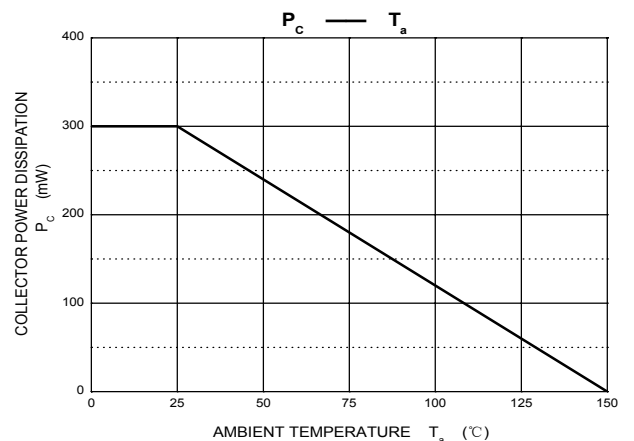
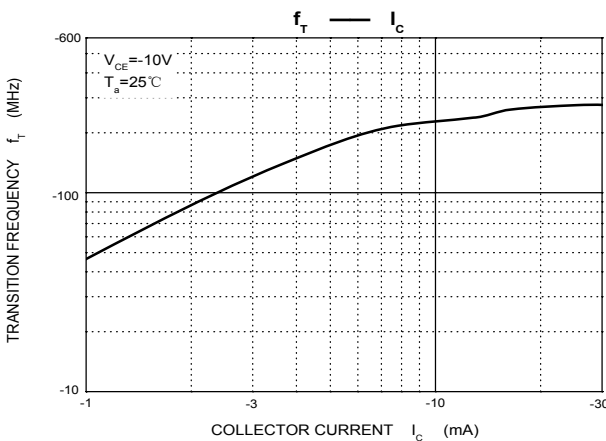
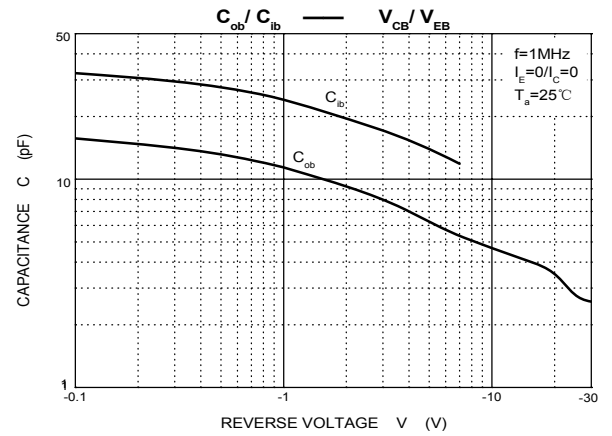
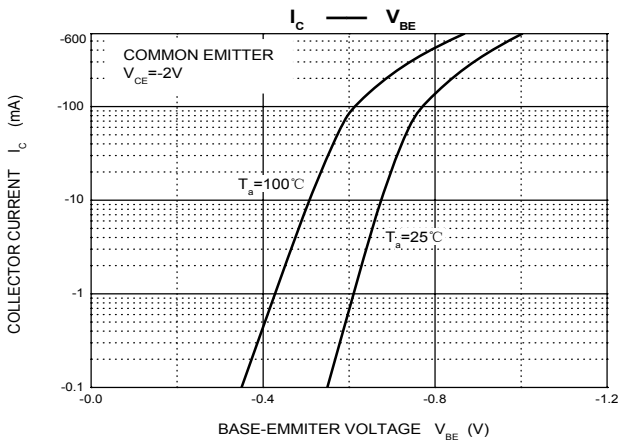
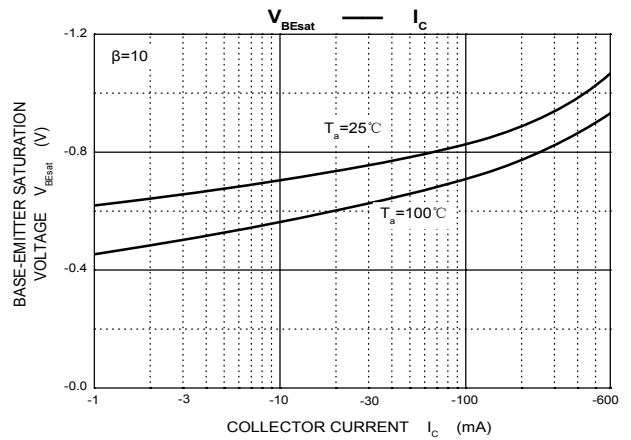
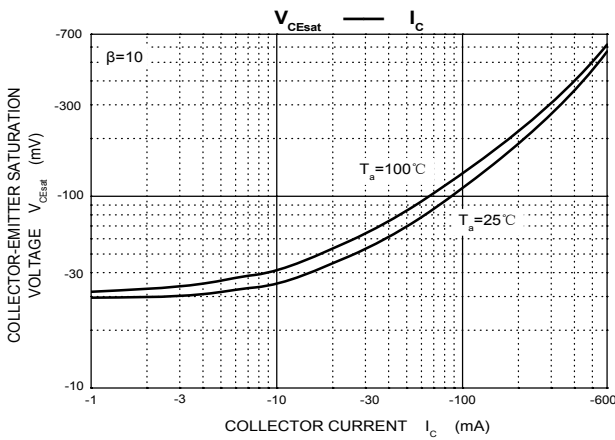
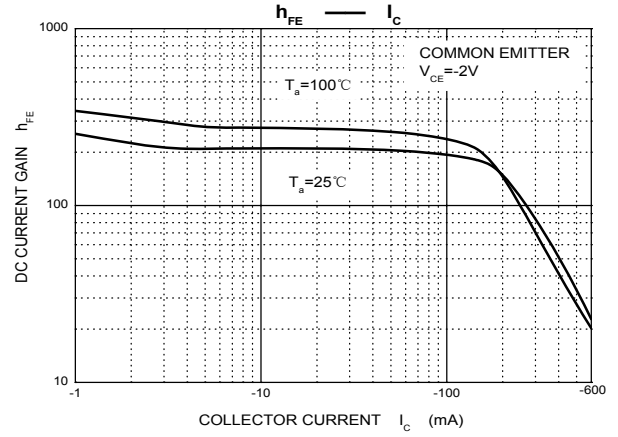
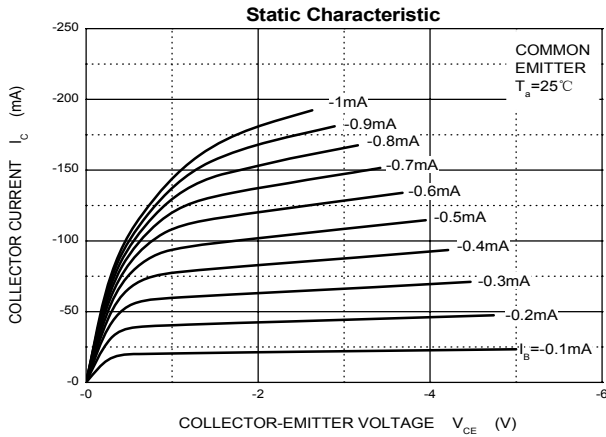

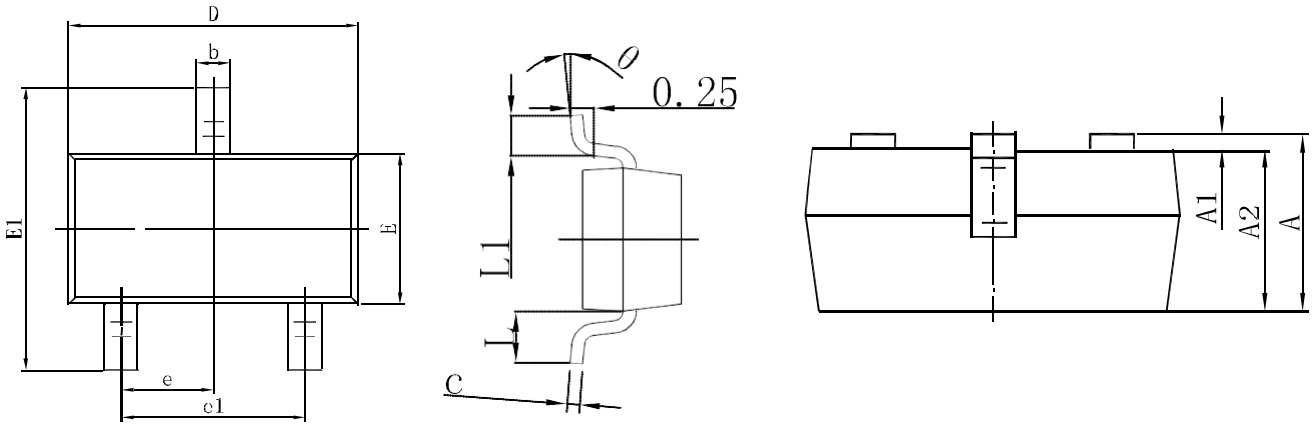
BIPOLAR TRANSISTOR (PNP)
SOT-23 Package Outline Dimensions

Symbol	Dimensions In Millimeters		Dimensions In Inches	
	Min.	Max.	Min.	Max.
A	0.900	1.150	0.035	0.045
A1	0.000	0.100	0.000	0.004
A2	0.900	1.050	0.035	0.041
b	0.300	0.500	0.012	0.020
c	0.080	0.150	0.003	0.006
D	2.800	3.000	0.110	0.118
E	1.200	1.400	0.047	0.055
E1	2.250	2.550	0.089	0.100
e	0.950 TYP		0.037 TYP	
e1	1.800	2.000	0.071	0.079
L	0.550 REF		0.022 REF	
L1	0.300	0.500	0.012	0.020
θ	0°	8°	0°	8°

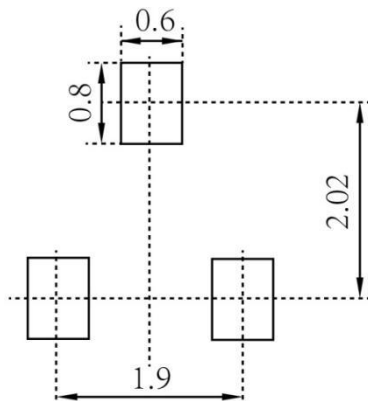
SOT-23 Suggested Pad Layout

Note:

1. Controlling dimension: in millimeters
2. General tolerance: $\pm 0.05\text{mm}$
3. The pad layout is for reference purposes only

BIPOLAR TRANSISTOR (PNP)

SOT-23 Tape and Reel

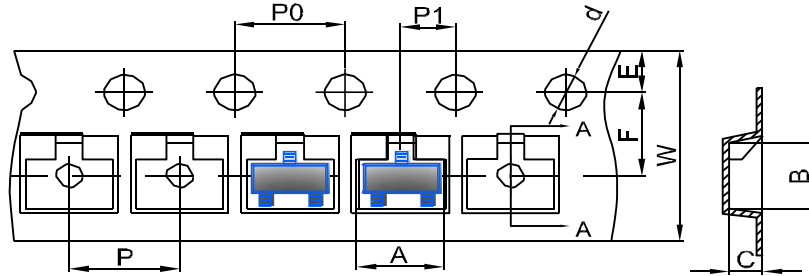
SOT-23 Embossed Carrier Tape



DIMENSIONS ARE IN MILLIMETER										
TYPE	A	B	C	d	E	F	P0	P	P1	W
SOT-23	3.15	2.77	1.22	Ø1.50	1.75	3.50	4.00	4.00	2.00	8.00
TOLERANCE	±0.1	±0.1	±0.1	±0.1	±0.1	±0.1	±0.1	±0.1	±0.1	±0.1

SOT-23 Tape Leader and Trailer

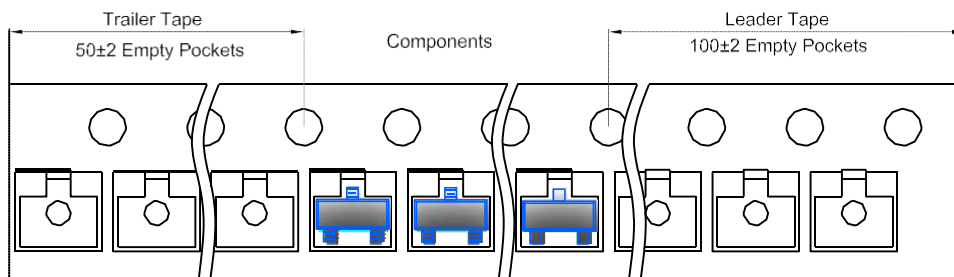

SOT-23 Reel

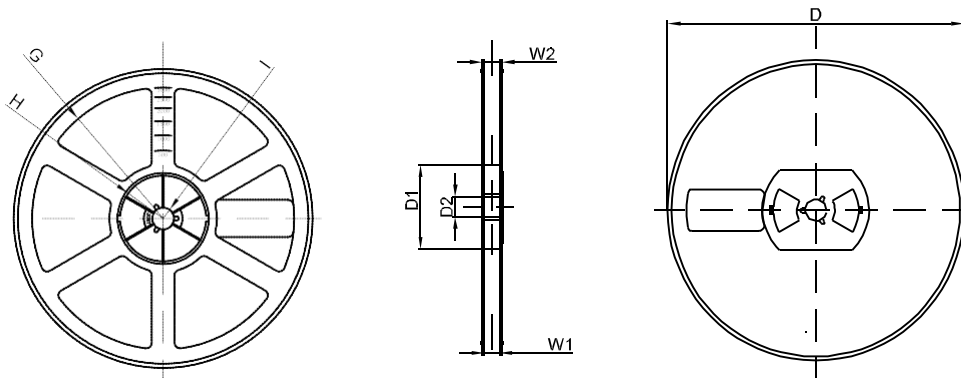

DIMENSIONS ARE IN MILLIMETER								
REEL OPTION	D	D1	D2	G	H	I	W1	W2
7" DIA	Ø178	54.40	13.00	R78	R25.60	R6.50	9.50	12.30
TOLERANCE	±2	±1	±1	±1	±1	±1	±1	±1