

Explanation of Symbols in This Catalog



Links are provided to the latest information from the PDF version of the catalog, which is available on the web.

	For applications that do not require a particular reliability, such as general equipment.		No DC bias characteristics Polymer capacitor is no capacitance change with DC bias due to aluminum oxidized film for dielectric.																												
	Infotainment for Automotive The product for entertainment equipment like car navigations, car audios, and body control equipment like wipers, power windows.		Low-inductance product suitable for noise suppression. This product has extremely low ESL and is suitable for suppression of noise, including high frequencies. This product can also be used as a low-ESL, high-performance bypass capacitor.																												
	Powertrain/Safety for Automotive Products use for applications (running, turning, stopping, and safety devices) that particularly concern human life, such as in devices for automotive.		Product for bonding Since gold is used for the external electrodes, the capacitor can be mounted by die bonding/wire bonding.																												
	Medical-grade products for Implanted Medical Devices These products are intended for use in implanted medical devices such as cardiac pacemakers, cochlear implants, insulin pumps, and gastric electrostimulators. They are suitable for use in non-critical circuits.*1 *1 Non-critical circuits This term refers to circuits in implanted medical devices that are not directly linked to life support, i.e. circuits that will not directly endanger the life of the patient should the functionality of the device be reduced or halted by failure of the circuit.		Derating 1 This product is suitable when a voltage continuously applied to a capacitor in an operating circuit, is used below (derated) the rated voltage of the capacitor. This model guarantees the test conditions in the endurance test, at a rated voltage x 100% at the maximum operating temperature. A reliability assurance level equivalent to a common product can be secured, by using this product within the voltage and temperature derated conditions recommended in the figure below.																												
	AEC-Q200 compliant product	Recommended Conditions of the Derating Operating Voltage and Temperature <table border="1"> <caption>Operating Voltage/Rated Voltage (%) vs Product Temperature (°C)</caption> <thead> <tr> <th>Product Temperature (°C)</th> <th>125°C Type (%)</th> <th>105°C Type (%)</th> <th>85°C Type (%)</th> </tr> </thead> <tbody> <tr><td>0</td><td>100</td><td>100</td><td>100</td></tr> <tr><td>25</td><td>100</td><td>100</td><td>100</td></tr> <tr><td>50</td><td>100</td><td>100</td><td>100</td></tr> <tr><td>75</td><td>100</td><td>100</td><td>100</td></tr> <tr><td>100</td><td>100</td><td>100</td><td>100</td></tr> <tr><td>125</td><td>70</td><td>70</td><td>70</td></tr> </tbody> </table>		Product Temperature (°C)	125°C Type (%)	105°C Type (%)	85°C Type (%)	0	100	100	100	25	100	100	100	50	100	100	100	75	100	100	100	100	100	100	100	125	70	70	70
Product Temperature (°C)	125°C Type (%)	105°C Type (%)	85°C Type (%)																												
0	100	100	100																												
25	100	100	100																												
50	100	100	100																												
75	100	100	100																												
100	100	100	100																												
125	70	70	70																												
	Safety Standard Certified Product Products that acquired safety standard certification IEC60384-14 and products based on the Electrical Appliance and Material Safety Law of Japan.	Derating 2 When the product temperature exceeds 105°C, please use this product within the voltage and temperature derated conditions in the figure below. <table border="1"> <caption>Rated Voltage (%) vs Product Temperature (°C)</caption> <thead> <tr> <th>Product Temperature (°C)</th> <th>Rated Voltage 630V (%)</th> <th>Rated Voltage 450V (%)</th> </tr> </thead> <tbody> <tr><td>0</td><td>630</td><td>450</td></tr> <tr><td>25</td><td>630</td><td>450</td></tr> <tr><td>50</td><td>630</td><td>450</td></tr> <tr><td>75</td><td>630</td><td>450</td></tr> <tr><td>100</td><td>630</td><td>450</td></tr> <tr><td>125</td><td>450</td><td>350</td></tr> </tbody> </table>		Product Temperature (°C)	Rated Voltage 630V (%)	Rated Voltage 450V (%)	0	630	450	25	630	450	50	630	450	75	630	450	100	630	450	125	450	350							
Product Temperature (°C)	Rated Voltage 630V (%)	Rated Voltage 450V (%)																													
0	630	450																													
25	630	450																													
50	630	450																													
75	630	450																													
100	630	450																													
125	450	350																													
	Low dissipation for high frequency By devising ceramic materials and electrode materials, low dissipation is achieved in frequency bands of VHF, UHF, and microwave or beyond.																														
	Low inductance This capacitor is designed so that the parasitic inductance component (ESL) that the capacitor has on the high frequency side becomes lower.	Derating 3 Please apply the derating curve according to the operating temperature. Please refer to detailed specifications sheet for details.																													
	Fail safe product This capacitor is designed to prevent failures as much as possible by short mode.																														
	Product resistant to deflection cracking This capacitor is designed to prevent failures as much as possible by short mode caused by cracking when there is board deflection.																														
	Product with solder cracking suppression This capacitor is configured with metal terminals and leads connected to the chip. The metal terminals and leads relieve the stress from expansion and contraction of the solder, to suppress solder cracking.																														
	Product suitable for acoustic noise reduction and low distortion This product suppresses acoustic noise, which occurs when a ceramic capacitor is used, by devising the materials and configuration.																														

Selection Guide for Capacitors

			AEC-Q200	Safety standard	High Q	Low ESL	Anti-noise	Fail safe	Deflecting crack	Soldering crack	Effective Cap	EMI FIL®	Other	
General	GRM	P24												
	GRM	WEB											For LED backlight only	
	GA2	WEB												
	GA3	WEB												
	GJM	P91												
	GMA	P113											Wire bondable	
	GMD	P116											Wire bondable	
	GQM	P119												
	GR3	P130												
	GR4	WEB											For communication / information devices	
	GR7	WEB											Limited to camera flashes	
	GRJ	P132												
	KR3	P147												
	KRM	P144												
	LLA	P136												
	LLL	P138												
	LLM	P140												
	LLR	P142												
	NFM	P150												
	DE1	WEB												
	DE2	WEB												
	DEJ	WEB												
	DHR	WEB												
	RDE	WEB												
	DHK	WEB												
	DHS	WEB												
	ECAS	WEB												
	Medical Device	GCH	P152											For Implanted Medical Devices
	Info-tainment	GRT	WEB											
	Power-train	GCM	WEB											
		GC3	WEB											
		GCD	WEB											
GCE		WEB												
GCG		WEB											Limited to conductive glue mounting	
GCJ		WEB												
KC3		WEB												
KCA		WEB												
KCM		WEB												
NFM		WEB												
DE6		WEB												
RCE		WEB												
RH		WEB												

● Part Numbering

Chip Monolithic Ceramic Capacitors for General



(Part Number)

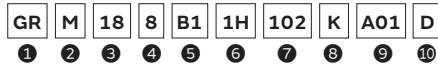

① Product ID ② Series

Product ID	Code	Series
GC	H	For implantable medical devices (Non-critical circuits)
GJ	M	High Q type for high frequency
GM	A	Wire bondable vertical electrode type
	D	Wire bondable/AuSn solderable type
GQ	M	High Q type for high frequency and high power
GR	3	High effective capacitance & High allowable ripple current
	J	Soft termination type
	M	General purpose products
KR	3	Metal terminal type/High effective capacitance & High allowable ripple current
	M	Metal terminal type
LL	A	8 terminal low ESL type
	L	LW reversed low ESL type
	M	10 terminal low ESL type
	R	ESR controlled low ESL type

③ Chip Dimensions (LxW)

Code	Dimensions (LxW)	EIA
02	0.4x0.2mm	01005
0D	0.38x0.38mm	015015
03	0.6x0.3mm	0201
05	0.5x0.5mm	0202
08	0.8x0.8mm	0303
1U	0.6x1.0mm	02404
15	1.0x0.5mm	0402
18	1.6x0.8mm	0603
21	2.0x1.25mm	0805
22	2.8x2.8mm	1111
31	3.2x1.6mm	1206
32	3.2x2.5mm	1210
42	4.5x2.0mm	1808
43	4.5x3.2mm	1812
55	5.7x5.0mm	2220

Continued on the following page. ↗

(Part Number)

GR	M	18	8	B1	1H	102	K	A01	D
①	②	③	④	⑤	⑥	⑦	⑧	⑨	⑩

Continued from the preceding page. ↘

④ Height Dimension (T) (Except KR□)

Code	Dimension (T)
1	0.125mm
2	0.2mm
3	0.3mm
4	0.4mm
5	0.5mm
6	0.6mm
7	0.7mm
8	0.8mm
9	0.85mm
A	1.0mm
B	1.25mm
C	1.6mm
D	2.0mm
E	2.5mm
M	1.15mm
Q	1.5mm
S	2.8mm
X	Depends on individual standards.

④ Height Dimension (T) (KR□ Only)

Code	Dimension (T)
E	1.8mm
F	1.9mm
K	2.7mm
L	2.8mm
Q	3.7mm
T	4.8mm
W	6.4mm

⑤ Temperature Characteristics

Temperature Characteristic Codes		Temperature Characteristics				Operating Temperature Range	Capacitance Change Each Temperature (%)					
Code	Public STD Code	Reference Temperature	Temperature Range	Capacitance Change or Temperature Coefficient	-55°C		*4		-10°C			
					Max.		Min.	Max.	Min.	Max.	Min.	
1X	SL	JIS	20°C	20 to 85°C	+350 to -1000ppm/°C	-55 to 125°C	-	-	-	-	-	-
2C	CH	JIS	20°C	20 to 125°C	0±60ppm/°C	-55 to 125°C	0.82	-0.45	0.49	-0.27	0.33	-0.18
3C	CJ	JIS	20°C	20 to 125°C	0±120ppm/°C	-55 to 125°C	1.37	-0.9	0.82	-0.54	0.55	-0.36
3U	UJ	JIS	20°C	20 to 85°C	-750±120ppm/°C	-25 to 85°C	-	-	4.94	2.84	3.29	1.89
4C	CK	JIS	20°C	20 to 125°C	0±250ppm/°C	-55 to 125°C	2.56	-1.88	1.54	-1.13	1.02	-0.75
5C	C0G	EIA	25°C	25 to 125°C	0±30ppm/°C	-55 to 125°C	0.58	-0.24	0.4	-0.17	0.25	-0.11
5G	X8G	*2	25°C	25 to 150°C	0±30ppm/°C	-55 to 150°C	0.58	-0.24	0.4	-0.17	0.25	-0.11
7U	U2J	EIA	25°C	25 to 125°C *3	-750±120ppm/°C	-55 to 125°C	8.78	5.04	6.04	3.47	3.84	2.21
B1	B *1	JIS	20°C	-25 to 85°C	±10%	-25 to 85°C	-	-	-	-	-	-
B3	B	JIS	20°C	-25 to 85°C	±10%	-25 to 85°C	-	-	-	-	-	-
C7	X7S	EIA	25°C	-55 to 125°C	±22%	-55 to 125°C	-	-	-	-	-	-
C8	X6S	EIA	25°C	-55 to 105°C	±22%	-55 to 105°C	-	-	-	-	-	-
D7	X7T	EIA	25°C	-55 to 125°C	+22%, -33%	-55 to 125°C	-	-	-	-	-	-
D8	X6T	EIA	25°C	-55 to 105°C	+22%, -33%	-55 to 105°C	-	-	-	-	-	-
E7	X7U	EIA	25°C	-55 to 125°C	+22%, -56%	-55 to 125°C	-	-	-	-	-	-
R1	R *1	JIS	20°C	-55 to 125°C	±15%	-55 to 125°C	-	-	-	-	-	-
R6	X5R	EIA	25°C	-55 to 85°C	±15%	-55 to 85°C	-	-	-	-	-	-
R7	X7R	EIA	25°C	-55 to 125°C	±15%	-55 to 125°C	-	-	-	-	-	-

*1 Capacitance change is specified with 50% rated voltage applied.
 *2 Murata Temperature Characteristic Code.
 *3 Rated Voltage 100Vdc max: 25 to 85°C
 *4 -25°C (Reference Temperature 20°C) / -30°C (Reference Temperature 25°C)

Continued on the following page. ↗

(Part Number)

GR	M	18	8	B1	1H	102	K	A01	D
1	2	3	4	5	6	7	8	9	10

Continued from the preceding page. ↘

⑥ Rated Voltage

Code	Rated Voltage
OE	DC2.5V
OG	DC4V
OJ	DC6.3V
1A	DC10V
1C	DC16V
1E	DC25V
1H	DC50V
1J	DC63V
1K	DC80V
2A	DC100V
2D	DC200V
2E	DC250V
2W	DC450V
2H	DC500V
2J	DC630V
3A	DC1kV
3D	DC2kV
3F	DC3.15kV
YA	DC35V

⑦ Capacitance

Expressed by three-digit alphanumerics. The unit is picofarad (pF). The first and second figures are significant digits, and the third figure expresses the number of zeros which follow the two numbers. If there is a decimal point, it is expressed by the capital letter "R." In this case, all figures are significant digits. If any alphabet, other than "R", is included, this indicates the specific part number is a non-standard part.

Ex.)

Code	Capacitance
R50	0.50pF
1R0	1.0pF
100	10pF
103	10000pF

⑧ Capacitance Tolerance

Code	Capacitance Tolerance
B	±0.1pF
C	±0.25pF
D	±0.5pF (Less than 10pF) ±0.5% (10pF and over)
F	±1%
G	±2%
J	±5%
K	±10%
M	±20%
W	±0.05pF

⑨ Individual Specification Code (Except LLR)

Expressed by three figures.

⑨ ESR (LLR Only)

Code	ESR
E01	100mΩ
E03	220mΩ
E05	470mΩ
E07	1000mΩ

⑩ Packaging

Code	Packaging
L	ø180mm Embossed Taping
D/E/W	ø180mm Paper Taping
K	ø330mm Embossed Taping
J/F	ø330mm Paper Taping
B	Bulk
C	Bulk Case
T	Bulk Tray

Please contact us if you find any part number not provided in this table.

Capacitance Table

p00 Each number in the Part Number List refers to the page number printed at the bottom of the page.

How to read the Capacitance Table

L×W (mm)	0.4×0.2		0.6		
T max. (mm)	0.22		0		
Rated Voltage (Vdc)	25		50		
Cap. / TC Code	COG	CΔ	COG	CK	CJ
0.10pF					
0.20pF	p92	p95	p98	p98	
1.0pF	p92	p95		p98	
2.0pF	p92	p95		p98	
3.0pF	p92	p95			p98

→ The values can be narrowed down in the order of size, rated voltage, and temperature characteristics.

→ Refers to the page of the part number list. Check the part number list for the applicable product number.

Temperature Characteristics Table

The Table is colored by temperature characteristic codes. Refer to the following Table for the meaning of each code.

EIA:	COG	U2J	X7R	X7S	X7T	X7U	X6S	X6T	X5R
JIS:	CK	CJ	CH	SL	UJ	R	B		
Murata Temperature Characteristic:	X8G								

Temperature Characteristic Codes		Temperature Characteristics			Operating Temperature Range	Capacitance Change Each Temperature (%)					
Public STD Code	Reference Temperature	Temperature Range	Capacitance Change or Temperature Coefficient	-55°C		*3		-10°C			
				Max.		Min.	Max.	Min.	Max.	Min.	
COG	EIA	25°C	25 to 125°C	0±30ppm/°C	-55 to 125°C	0.58	-0.24	0.4	-0.17	0.25	-0.11
CK	JIS	20°C	20 to 125°C	0±250ppm/°C	-55 to 125°C	2.56	-1.88	1.54	-1.13	1.02	-0.75
CJ	JIS	20°C	20 to 125°C	0±120ppm/°C	-55 to 125°C	1.37	-0.9	0.82	-0.54	0.55	-0.36
CH	JIS	20°C	20 to 125°C	0±60ppm/°C	-55 to 125°C	0.82	-0.45	0.49	-0.27	0.33	-0.18
SL	JIS	20°C	20 to 85°C	+350 to -1000ppm/°C	-55 to 125°C	-	-	-	-	-	-
U2J	EIA	25°C	25 to 125°C *2	-750±120ppm/°C	-55 to 125°C	8.78	5.04	6.04	3.47	3.84	2.21
UJ	JIS	20°C	20 to 85°C	-750±120ppm/°C	-25 to 85°C	-	-	4.94	2.84	3.29	1.89
X8G	*1	25°C	25 to 150°C	0±30ppm/°C	-55 to 150°C	0.58	-0.24	0.4	-0.17	0.25	-0.11
X7R	EIA	25°C	-55 to 125°C	±15%	-55 to 125°C	-	-	-	-	-	-
X7S	EIA	25°C	-55 to 125°C	±22%	-55 to 125°C	-	-	-	-	-	-
X7T	EIA	25°C	-55 to 125°C	+22%, -33%	-55 to 125°C	-	-	-	-	-	-
X7U	EIA	25°C	-55 to 125°C	+22%, -56%	-55 to 125°C	-	-	-	-	-	-
R	JIS	20°C	-55 to 125°C	±15%	-55 to 125°C	-	-	-	-	-	-
X6S	EIA	25°C	-55 to 105°C	±22%	-55 to 105°C	-	-	-	-	-	-
X6T	EIA	25°C	-55 to 105°C	+22%, -33%	-55 to 105°C	-	-	-	-	-	-
X5R	EIA	25°C	-55 to 85°C	±15%	-55 to 85°C	-	-	-	-	-	-
B	JIS	20°C	-25 to 85°C	±10%	-25 to 85°C	-	-	-	-	-	-

*1 Murata Temperature Characteristic Code.

*2 Rated Voltage 100Vdc max: 25 to 85°C

*3 -25°C (Reference Temperature 20°C) / -30°C (Reference Temperature 25°C)

Capacitance Table

p00 Each number in the Part Number List refers to the page number printed at the bottom of the page.

GRM Series Temperature Compensating Type

p00 ← Part Number List JIS: **CK** **CJ** **CH** **SL** **UJ** EIA: **COG** **U2J**

L×W (mm)	0.4×0.2				0.6×0.3				1.0×0.5				1.6×0.8						
	0.22				0.33				0.55				0.9						
	50		25		100		50		100		50		10		50		10		
Rated Voltage (Vdc)	COG	CA	COG	CH	COG	CA	COG	CA	COG	CA	COG	CA	SL	U2J	UJ	SL	U2J	UJ	
Cap. / TC Code	COG	CA	COG	CH	COG	CA	COG	CA	COG	CA	COG	CA	SL	U2J	UJ	SL	U2J	UJ	
0.10pF					p32	p35	p38	p41			p45	p48	p52	p55					
0.20pF	p25	p28			p32	p35	p38	p41			p45	p48	p52	p55					
0.50pF	p25	p28			p32	p35	p38	p41			p45	p49	p52	p55					
1.0pF	p25	p28			p32	p35	p38	p41			p45	p49	p52	p56					
2.0pF	p25	p28			p32	p35	p38	p42			p46	p49	p52	p56					
3.0pF	p25	p29			p32	p35	p39	p42			p46	p49	p53	p56					
4.0pF	p26	p29			p33	p36	p39	p42			p46	p49	p53	p56					
5.0pF	p26	p29			p33	p36	p39	p43			p46	p50	p53	p57					
6.0pF	p26	p30			p33	p36	p40	p43			p47	p50	p53	p57					
7.0pF	p27	p30			p34	p37	p40	p43			p47	p50	p54	p57					
8.0pF	p27	p30			p34	p37	p40	p44			p47	p51	p54	p58					
9.0pF	p27	p31			p34	p37	p41	p44			p48	p51	p55	p58					
10pF	p28	p31			p35	p38	p41	p44			p48	p52	p55	p59					
11pF	p28	p31																	
12pF	p28	p31			p35	p38	p41	p44			p48	p52	p55	p59					
13pF	p28	p31																	
15pF	p28	p31			p35	p38	p41	p44			p48	p52	p55	p59					
16pF	p28	p31																	
17pF	p28	p31																	
18pF	p28	p31					p41	p45			p48	p52	p55	p59					
19pF	p28	p31																	
20pF	p28	p31																	
21pF	p28	p31																	
22pF	p28	p31					p41	p45			p48	p52	p55	p59					
23pF	p28	p31																	
24pF	p28	p31																	
27pF	p28	p31					p41	p45			p48	p52	p55	p59					
30pF	p28	p31																	
33pF	p28	p31					p41	p45			p48	p52	p55	p59					
36pF	p28	p31																	
39pF	p28	p31					p41	p45			p48	p52	p55	p59					
43pF	p28	p31																	
47pF	p28	p31					p41	p45			p48	p52	p55	p59					
51pF	p28	p31																	
56pF	p28	p31					p41	p45			p48	p52	p55	p59					
62pF	p28	p31																	
68pF	p28	p31					p41	p45			p48	p52	p55	p59					
75pF	p28	p31																	
82pF	p28	p31					p41	p45			p48	p52	p55	p59					
91pF	p28	p31																	
100pF	p28	p31					p41	p45			p48	p52	p55	p59					
120pF			p31	p31	p31	p31			p41	p45			p55	p59					
150pF			p31	p31	p31	p32			p41	p45			p55	p59					
180pF			p31	p31	p31	p32			p41	p45			p55	p59					
220pF			p31	p31	p31	p32			p41	p45			p55	p59					
270pF									p45	p45			p55	p59					
330pF									p45	p45			p55	p59					
390pF									p45	p45			p55	p59					
470pF									p45	p45			p55	p59					
560pF									p45	p45			p55	p59					
680pF									p45	p45			p55	p59					
820pF									p45	p45			p55	p59					
910pF									p45										
1000pF									p45	p45			p55	p59					
1200pF														p59	p59	p59			
1500pF														p59	p59	p59			
1800pF														p59	p59	p59			
2200pF														p59	p59	p59			
2700pF														p59	p59	p59			
3300pF														p59	p59	p59			
3900pF														p59	p59	p59			
4700pF														p59	p59	p59			
5600pF																	p59	p59	p59
6800pF																	p59	p59	p59
8200pF																	p59	p59	p59
10000pF																	p59	p59	p59
12000pF																			
15000pF																			
18000pF																			
22000pF																			
27000pF																			
33000pF																			
39000pF																			
47000pF																			
56000pF																			
68000pF																			
82000pF																			
0.10μF																			
0.12μF																			

The indication for every 0.1 pF has been omitted for less than 10 pF. Refer to the Part Number List for details.

Continued on the following page. ↗

Capacitance Table

p00 Each number in the Part Number List refers to the page number printed at the bottom of the page.

(→ GRM Series Temperature Compensating Type)

p00 ← Part Number List	JIS: CK CJ CH SL UJ										EIA: COG U2J																													
	1.6×0.8					0.9					0.7					2.0×1.25																								
	0.9					10					100					0.95					1.0																			
L×W (mm)	0.9										0.7										0.95										1.0									
T max. (mm)	0.9										0.7										0.95										1.0									
Rated Voltage (Vdc)	50					10					100					50					10					250					200									
Cap. / TC Code	COG	CA	SL	U2J	UJ	SL	U2J	UJ	COG	CH	COG	CH	SL	U2J	UJ	COG	CH	SL	U2J	UJ	SL	U2J	UJ	COG	U2J	COG	U2J													
0.10pF																																								
0.20pF																																								
0.50pF	p66	p69																																						
1.0pF	p66	p70																																						
2.0pF	p66	p70																																						
3.0pF	p67	p70																																						
4.0pF	p67	p70																																						
5.0pF	p67	p71																																						
6.0pF	p68	p71																																						
7.0pF	p68	p71																																						
8.0pF	p68	p72																																						
9.0pF	p69	p72																																						
10pF	p69	p73																								p74	p75													
11pF																																								
12pF	p69	p73																								p74	p75													
13pF																																								
15pF	p69	p73																								p74	p75													
16pF																																								
17pF																																								
18pF	p69	p73																								p74	p75													
19pF																																								
20pF																																								
21pF																																								
22pF	p69	p73																								p74	p75													
23pF																																								
24pF																																								
27pF	p69	p73																								p74	p75													
30pF																																								
33pF	p69	p73																								p74	p75													
36pF																																								
39pF	p69	p73																								p74	p75													
43pF																																								
47pF	p69	p73																								p74	p75													
51pF																																								
56pF	p69	p73																								p74	p75													
62pF																																								
68pF	p69	p73																								p74	p75													
75pF																																								
82pF	p69	p73																								p74	p75													
91pF																																								
100pF	p69	p73								p73	p74															p74	p74	p75	p75											
120pF	p69	p73								p73	p74															p74	p74	p75	p75											
150pF	p69	p73								p73	p74	p74	p74													p74	p74	p75	p75											
180pF	p69	p73								p74	p74	p74	p74													p74	p74	p75	p75											
220pF	p69	p73								p74	p74	p74	p74													p74	p74	p75	p75											
270pF	p69	p73								p74	p74	p74	p74													p74	p74	p75	p75											
330pF	p69	p73								p73	p74															p74	p74	p75	p75											
390pF	p69	p73								p73	p74															p74	p74		p75											
470pF	p69	p73								p73	p74															p74	p75		p75											
560pF	p69	p73								p73	p74															p74	p75		p75											
680pF	p69	p73								p73	p74															p74	p75		p75											
820pF	p69	p73								p73	p74															p74	p75		p75											
910pF																																								
1000pF	p69	p73								p73	p74															p74	p75		p75											
1200pF	p69	p73	p73	p73	p73					p73	p74	p74	p74													p74	p75		p75											
1500pF	p69	p73	p73	p73	p73					p73	p74	p74	p74													p74	p75		p75											
1800pF	p69	p73	p73	p73	p73					p74	p74	p74	p74													p74	p75		p75											
2200pF	p69	p73	p73	p73	p73					p74	p74	p74	p74													p74	p75		p75											
2700pF	p69	p73	p73	p73	p73					p74	p74	p74	p74													p74														
3300pF	p69	p73	p73	p73	p73					p74	p74	p74	p74																											
3900pF	p69	p73	p73	p73	p73																																			
4700pF	p69	p73	p73	p73	p73																																			
5600pF	p69	p73	p73	p73	p73																					p74	p74													
6800pF	p69	p73	p73	p73	p73																					p74	p74													
8200pF	p69	p73	p73	p73	p73																					p74	p74													
10000pF	p69	p73	p73	p73	p73																						p74	p74												
12000pF										p73	p73	p73															p74	p74												
15000pF										p73	p73	p73															p74	p74												
18000pF										p73	p73	p73															p74	p74												
22000pF										p73	p73	p73															p74	p74												
27000pF																											p74	p74												
33000pF																											p74	p74												
39000pF																																								
47000pF																																								
56000pF																											p74	p74	p74											
68000pF																																								
82000pF																																								
0.10μF																																								
0.12μF																																								

separate volume
2

Continued on the following page. ↗

Capacitance Table

p00 Each number in the Part Number List refers to the page number printed at the bottom of the page.

(→ GRM Series Temperature Compensating Type)

L×W (mm)	2.0×1.25												3.2×1.6															
	1.0			1.35						1.45			0.95				1.0											
	50			50			10			250		200	100		50		2000		1000		630		500					
Rated Voltage (Vdc)	SL	U2J	UJ	COG	CH	SL	U2J	UJ	SL	U2J	UJ	COG	U2J	U2J	COG	CH	COG	CH	SL	U2J	UJ	U2J	COG	U2J	COG	U2J	COG	
Cap. / TC Code																												
0.10pF																												
0.20pF																												
0.50pF																												
1.0pF																												
2.0pF																												
3.0pF																												
4.0pF																												
5.0pF																												
6.0pF																												
7.0pF																												
8.0pF																												
9.0pF																												
10pF																												
11pF																												
12pF																												
13pF																												
15pF																												
16pF																												
17pF																												
18pF																												
19pF																												
20pF																												
21pF																												
22pF																												
23pF																												
24pF																												
27pF																												
30pF																												
33pF																												
36pF																												
39pF																												
43pF																												
47pF																												
51pF																												
56pF																												
62pF																												
68pF																												
75pF																												
82pF																												
91pF																												
100pF																												
120pF																												
150pF																												
180pF																												
220pF																												
270pF																												
330pF																												
390pF																												
470pF																												
560pF																												
680pF																												
820pF																												
910pF																												
1000pF																												
1200pF																												
1500pF																												
1800pF																												
2200pF																												
2700pF																												
3300pF																												
3900pF																												
4700pF																												
5600pF																												
6800pF																												
8200pF																												
10000pF																												
12000pF																												
15000pF																												
18000pF																												
22000pF																												
27000pF																												
33000pF																												
39000pF																												
47000pF																												
56000pF																												
68000pF																												
82000pF																												
0.10μF																												
0.12μF																												

Continued on the following page. ↗

Capacitance Table

p00 Each number in the Part Number List refers to the page number printed at the bottom of the page.

(→ GRM Series Temperature Compensating Type)

p00 ← Part Number List	JIS: CK CJ CH SL UJ				EIA: COG U2J																			
	L×W (mm)				3.2×1.6																			
	T max. (mm)				1.0																			
Rated Voltage (Vdc)	1.0				1.25												1.8							
	500	250	200		1000	630	500	250	200	100	50	1000	630	500	250									
Cap. / TC Code	U2J	COG	U2J	U2J	COG	U2J	COG	U2J	COG	U2J	COG	UH	COG	CH	SL	U2J	UJ	COG	U2J	COG	U2J	COG	U2J	
0.10pF																								
0.20pF																								
0.50pF																								
1.0pF																								
2.0pF																								
3.0pF																								
4.0pF																								
5.0pF																								
6.0pF																								
7.0pF																								
8.0pF																								
9.0pF																								
10pF																								
11pF																								
12pF																								
13pF																								
15pF																								
16pF																								
17pF																								
18pF																								
19pF																								
20pF																								
21pF																								
22pF																								
23pF																								
24pF																								
27pF																								
30pF																								
33pF																								
36pF																								
39pF																								
43pF																								
47pF																								
51pF																								
56pF																								
62pF																								
68pF																								
75pF																								
82pF																								
91pF																								
100pF																								
120pF																								
150pF																								
180pF																								
220pF																								
270pF																								
330pF																								
390pF																								
470pF																								
560pF																								
680pF																								
820pF																								
910pF																								
1000pF																								
1200pF																								
1500pF																								
1800pF																								
2200pF																								
2700pF																								
3300pF																								
3900pF																								
4700pF																								
5600pF																								
6800pF																								
8200pF																								
10000pF																								
12000pF																								
15000pF																								
18000pF																								
22000pF																								
27000pF																								
33000pF																								
39000pF																								
47000pF																								
56000pF																								
68000pF																								
82000pF																								
0.10μF																								
0.12μF																								

Capacitance Table

p00 Each number in the Part Number List refers to the page number printed at the bottom of the page.

(→ GRM Series Temperature Compensating Type)

p00 ← Part Number List	JIS: CK CJ CH SL UJ			EIA: COG U2J					
	4.5×3.2			5.7×5.0					
L×W (mm)	4.5×3.2			1.5			2.0		
T max. (mm)	2.0			1.5			2.0		
Rated Voltage (Vdc)	1000	630	500	1000	630	500	1000	630	500
Cap. / TC Code	U2J	U2J	U2J	U2J	U2J	U2J	U2J	U2J	U2J
0.10pF									
0.20pF									
0.50pF									
1.0pF									
2.0pF									
3.0pF									
4.0pF									
5.0pF									
6.0pF									
7.0pF									
8.0pF									
9.0pF									
10pF									
11pF									
12pF									
13pF									
15pF									
16pF									
17pF									
18pF									
19pF									
20pF									
21pF									
22pF									
23pF									
24pF									
27pF									
30pF									
33pF									
36pF									
39pF									
43pF									
47pF									
51pF									
56pF									
62pF									
68pF									
75pF									
82pF									
91pF									
100pF									
120pF									
150pF									
180pF									
220pF									
270pF									
330pF									
390pF									
470pF									
560pF									
680pF									
820pF									
910pF									
1000pF									
1200pF									
1500pF									
1800pF									
2200pF									
2700pF									
3300pF									
3900pF	p79								
4700pF	p79								
5600pF				p79					
6800pF				p79					
8200pF							p79		
10000pF							p79		
12000pF									
15000pF		p79	p79						
18000pF		p79	p79						
22000pF		p79	p79						
27000pF					p79	p79			
33000pF								p79	p79
39000pF								p79	p79
47000pF								p79	p79
56000pF									
68000pF									
82000pF									
0.10μF									
0.12μF									

Capacitance Table

p00 Each number in the Part Number List refers to the page number printed at the bottom of the page.

GRM Series High Dielectric Constant Type

p00 ← Part Number List JIS: R B EIA: X7R X7S X7T X7U X6S X6T X5R

L×W (mm)	0.4×0.2										0.6×0.3										1.0×0.5						
	0.22										0.33										0.22						
T max. (mm)	0.22										0.33										0.22						
Rated Voltage (Vdc)	16	10	6.3	4	2.5	50	35	25	16	10	6.3	4	10	6.3	4	16	10	6.3	4	10	6.3	4	10	6.3	4		
Cap. / TC Code	X7R	X7R	X5R, B	X5R, B	X6T	X5R	X6T	X7R	B	X5R	X7R, R	X6S	X5R, B	X7Δ, R	X6S	X5R, B	X7Δ, R	X5R, B	X7R, R	X6S	X5R, B	X6S	X5R, B	X6S	X5R, B	X7T	X6Δ
100pF	p80	p80	p80	p80				p81	p81		p81																
150pF	p80	p80	p80	p80				p81	p81		p81																
220pF	p80	p80	p80	p80				p81	p81		p81																
330pF	p80	p80	p80	p80				p81	p81		p81																
470pF	p80	p80	p80	p80				p81	p81		p81																
680pF		p80	p80	p80				p81	p81		p81																
820pF		p80																									
1000pF	p80	p80	p80	p80	p80			p81	p81		p81	p81		p81													
1500pF			p80	p80	p80	p80		p81	p81		p81	p81		p81													
2200pF			p80	p80	p80	p80					p81					p82											
3300pF			p80	p80	p80	p80					p81					p82											
4700pF			p80	p80	p80	p80					p81					p82	p82	p82	p82	p82				p82			
6800pF			p80	p80	p80	p80					p81					p82	p82	p82	p82	p82				p82			
10000pF			p80	p80	p80	p80					p81					p81	p81	p81									
15000pF				p80		p80										p81	p82		p82	p82				p82	p82		
22000pF				p80		p80										p81	p82		p82	p82				p82	p82		
33000pF				p80		p81										p81	p82		p82	p82				p82	p82		
47000pF				p80		p81										p82	p82		p82	p82				p82			
68000pF				p80		p81										p82	p82		p82	p82				p82			
0.10μF				p80	p80	p81	p81			p81			p81	p81	p81	p81	p82	p82	p82	p82				p82	p82	p82	p82
0.15μF																									p82	p83	p83
0.22μF																									p82	p82	p82
0.33μF																											
0.47μF																										p83	p83
0.68μF																											
1.0μF																										p83	p83
2.2μF																											
4.7μF																											
10μF																											
22μF																											
47μF																											
100μF																											
150μF																											
220μF																											

Continued on the following page. ↗

Capacitance Table

p00 Each number in the Part Number List refers to the page number printed at the bottom of the page.

(→ GRM Series High Dielectric Constant Type)

p00 ← Part Number List JIS: R B EIA: X7R X7S X7T X7U X6S X6T X5R

L×W (mm)	1.0×0.5																																
	0.22		0.3				0.33				0.55																						
T max. (mm)	2.5		50		25		16		10		10		6.3		4		100		50		35		25		16		10						
Rated Voltage (Vdc)	X5R	X7T	X7R,R	B	X7R	B	X7R	B	X5R	X5R,B	X6T	X5R,B	X6T	X7R	X7R,R	X6S	X5R,B	X6S	X5R	X7R,R	X6S	X5R,B	X7R,R	X6S	X5R,B	X7R	X6S						
Cap. / TC Code	X5R	X7T	X7R,R	B	X7R	B	X7R	B	X5R	X5R,B	X6T	X5R,B	X6T	X7R	X7R,R	X6S	X5R,B	X6S	X5R	X7R,R	X6S	X5R,B	X7R,R	X6S	X5R,B	X7R	X6S						
100pF																																	
150pF																																	
220pF			p83	p83	p83									p83	p83	p84										p84							
330pF			p83	p83	p83									p83	p83	p84											p84						
470pF			p83	p83	p83									p83	p83	p84											p84						
680pF			p83	p83	p83									p83	p83	p84											p84						
820pF																																	
1000pF			p83	p83	p83									p83	p83	p84											p84						
1500pF			p83	p83	p83									p83	p83	p84											p84						
2200pF					p83	p83								p83	p83	p84							p84			p84							
3300pF							p83	p83						p83	p83	p84																	
4700pF							p83	p83						p83	p84	p84											p85						
6800pF							p83	p83							p84	p84																	
10000pF							p83	p83							p84	p84									p84	p85		p85					
15000pF									p83						p84										p84	p85							
22000pF									p83						p84										p84	p85							
33000pF										p83						p84	p84								p84	p85							
47000pF											p83					p84	p84								p84	p85							
68000pF												p83					p84	p84							p84	p85	p85						
0.10μF		p83													p84										p84	p85							
0.15μF																											p85						
0.22μF		p83																								p84	p84	p84	p84	p85		p85	p85
0.33μF																																	
0.47μF																																	
0.68μF																																	
1.0μF	p83										p83	p83	p83	p83	p83											p84	p85					p85	
2.2μF																																	
4.7μF																																	
10μF																																	
22μF																																	
47μF																																	
100μF																																	
150μF																																	
220μF																																	

Continued on the following page. ↗

Capacitance Table

p00 Each number in the Part Number List refers to the page number printed at the bottom of the page.

(→ GRM Series High Dielectric Constant Type)

p00 ← Part Number List JIS: R B EIA: X7R X7S X7T X7U X6S X6T X5R

L×W (mm)	1.0×0.5																	1.6×0.8											
	0.55					0.6					0.65		0.7					0.5											
T max. (mm)	0.55					0.6					0.65		0.7					0.5											
Rated Voltage (Vdc)	10	6.3				4				35	25	16	6.3	4	2.5	10	6.3	25	16	10	6.3	4	2.5	25	16	6.3	4		
Cap. / TC Code	X5R, B	X7R	X6S	X5R, B	X7R	X6S	X5R	X5R	X6S	X6S	X5R, B	X6T	X5R	X6S	X5R	X6S	X5R	X6S	X5R	X7S	X6S	X7S	X5R	X5R	X5R, B	X5R, B	X5R	X5R	
100pF																													
150pF																													
220pF																													
330pF																													
470pF																													
680pF																													
820pF																													
1000pF																													
1500pF																													
2200pF																													
3300pF																													
4700pF																													
6800pF																													
10000pF																													
15000pF																													
22000pF																													
33000pF																													
47000pF																													
68000pF																													
0.10μF																													
0.15μF																													
0.22μF																													
0.33μF																													
0.47μF																													
0.68μF																													
1.0μF																													
2.2μF																													
4.7μF																													
10μF																													
22μF																													
47μF																													
100μF																													
150μF																													
220μF																													

Continued on the following page. ↗

Capacitance Table

p00 Each number in the Part Number List refers to the page number printed at the bottom of the page.

(→ GRM Series High Dielectric Constant Type)

p00 ← Part Number List JIS: R B EIA: X7R X7S X7T X7U X6S X6T X5R

L×W (mm)	1.6×0.8																								
	0.55					0.9							0.95				1.0								
T max. (mm)	0.55					0.9							0.95				1.0								
Rated Voltage (Vdc)	16	10	6.3	250	200	50	35	25	16	10	6.3	4	25	16	10	50	35								
Cap. / TC Code	X5R	X6S	X5R	X7T	X6S	X7R	X7R	X5R, B	X7R	X7R	X5R, B	X7R	X5R	X6S	X5R, B	X7R	X5R	X6S	X5R, B	X7S	X5R, B	X5R	X6S	X5R	
100pF																									
150pF																									
220pF						p86	p86																		
330pF						p86	p86																		
470pF						p86	p86																		
680pF						p86	p86																		
820pF																									
1000pF						p86	p86																		
1500pF						p86	p86																		
2200pF						p86	p86																		
3300pF																									
4700pF																									
6800pF																									
10000pF																									
15000pF																									
22000pF																									
33000pF																									
47000pF																									
68000pF																									
0.10μF																									
0.15μF																									
0.22μF																									
0.33μF																									
0.47μF																									
0.68μF																									
1.0μF																									
2.2μF																									
4.7μF	p86	p86	p86	p86	p86																				
10μF																									
22μF																									
47μF																									
100μF																									
150μF																									
220μF																									

Continued on the following page. ↗

Capacitance Table

p00 Each number in the Part Number List refers to the page number printed at the bottom of the page.

(→ GRM Series High Dielectric Constant Type)

p00 ← Part Number List JIS: R B EIA: X7R X7S X7T X7U X6S X6T X5R

L×W (mm)	1.6×0.8										2.0×1.25																								
	1.0										0.7	0.95									1.0														
T max. (mm)	1.0										0.7	0.95									1.0														
Rated Voltage (Vdc)	25			16			10			6.3			4			16	50	35	25			16			10			6.3			4			2.5	500
Cap. / TC Code	X7S	X6S	X5R	X7S	X6S	X7T	X7T	X5R, B	X6S	X5R, B	X6S	X5R, B	X6S	X5R	X7R	X6S	X5R, B	X7R	X6S	X5R, B	X7R	X6S	X5R, B	X7Δ	X5R, B	X6S	X5R, B	X6S	X5R	X6T	X7R				
100pF																																			
150pF																																			
220pF																																			
330pF																																			
470pF																																			
680pF																																			
820pF																																			
1000pF																																			
1500pF																																			
2200pF																																			
3300pF																																			
4700pF																																			
6800pF																																			
10000pF																																			
15000pF																																			
22000pF																																			
33000pF																																			
47000pF																																			
68000pF																																			
0.10μF																																			
0.15μF																																			
0.22μF																																			
0.33μF																																			
0.47μF																																			
0.68μF																																			
1.0μF																																			
2.2μF	p87	p87																																	
4.7μF		p87																																	
10μF			p87																																
22μF				p87	p87	p87																													
47μF																																			
100μF																																			
150μF																																			
220μF																																			

Continued on the following page. ↗

Capacitance Table

p00 Each number in the Part Number List refers to the page number printed at the bottom of the page.

(→ GRM Series High Dielectric Constant Type)

p00 ← Part Number List JIS: R B EIA: X7R X7S X7T X7U X6S X6T X5R

L×W (mm)	2.0×1.25																											
	1.0				1.35				1.4					1.45														
T max. (mm)	250	200	35	25	16	50	25	16	50	25	16	10	6.3	4	500	250	200	50										
Rated Voltage (Vdc)	X7R	X7R	X6S	X7S	X6S	X7S	X5R	X5R, B	X6S	X5R, B	X7R	X5R, B	X5R, B	X7R, R	X5R, B	X7R	X6S	X7R	B	X7R	X6S	X7U	X6S	X7R	X7R	X7R	X7S	
Cap. / TC Code	X7R	X7R	X6S	X7S	X6S	X7S	X5R	X5R, B	X6S	X5R, B	X7R	X5R, B	X5R, B	X7R, R	X5R, B	X7R	X6S	X7R	B	X7R	X6S	X7U	X6S	X7R	X7R	X7R	X7S	
100pF																												
150pF																												
220pF																												
330pF																												
470pF																												
680pF																												
820pF																												
1000pF	p87	p87																										
1500pF	p87	p87																										
2200pF	p87	p87																										
3300pF	p87	p87																										
4700pF	p87	p87																										
6800pF	p87	p87																										
10000pF																									p88	p88	p88	
15000pF																										p88	p88	
22000pF																										p88	p88	
33000pF																												
47000pF																												
68000pF																												
0.10μF																												
0.15μF																												
0.22μF																												
0.33μF																												
0.47μF																												
0.68μF																												
1.0μF								p87	p87																			
2.2μF									p87	p88																		
4.7μF		p87	p87	p87	p87				p87	p87	p87																	
10μF																												p88
22μF																												
47μF							p87																					
100μF																												
150μF																												
220μF																												

Continued on the following page. ↗

Capacitance Table

p00 Each number in the Part Number List refers to the page number printed at the bottom of the page.

(→ GRM Series High Dielectric Constant Type)

p00 ← Part Number List JIS: R B EIA: X7R X7S X7T X7U X6S X6T X5R

L×W (mm)	2.0×1.25															3.2×1.6												
	1.45															0.95				1.0	1.25							
T max. (mm)																												
Rated Voltage (Vdc)	50	35				25			16			10			6.3	4			2.5	35	16	10	6.3		630	1000	630	500
Cap. / TC Code	X6S	X7S	X6S	X5R	X7S	X6S	X5R	X7S	X6S	X5R	X7T	X6S	X5R	X7T	X5R,B	X6S	X5R,B	X6S	X5R	X5R,B	X5R,B	X6S	X5R,B	X7R	X7R	X7R	X7R	
100pF																												
150pF																												
220pF																												
330pF																												
470pF																												
680pF																												
820pF																												
1000pF																												
1500pF																												
2200pF																												
3300pF																												
4700pF																												
6800pF																												
10000pF																												
15000pF																												
22000pF																												
33000pF																												
47000pF																												
68000pF																												
0.10μF																												
0.15μF																												
0.22μF																												
0.33μF																												
0.47μF																												
0.68μF																												
1.0μF																												
2.2μF																												
4.7μF	p88	p88			p88																							
10μF			p88	p88	p88	p88			p88																			
22μF							p88		p88	p88	p88	p88	p88	p88														
47μF															p88	p88	p88	p88										
100μF																												
150μF																												
220μF																												

Continued on the following page. ↗

Capacitance Table

p00 Each number in the Part Number List refers to the page number printed at the bottom of the page.

(→ GRM Series High Dielectric Constant Type)

p00 ← Part Number List JIS: R B EIA: X7R X7S X7T X7U X6S X6T X5R

L×W (mm)	3.2×1.6																										
	1.25				1.8												1.9										
T max. (mm)	250	200	50	25	1000	630	500	250	200	100	50	25	16		10		6.3		4		100	25					
Rated Voltage (Vdc)	X7R	X7R	X7R	B	X5R	X7R	X7R	X7R	X7R	X7R	X7R	X5R, B	X7R	X5R, B	X7R	X6S	X5R, B	X7R	X5R, B	X7Δ	X6S	X5R, B	X7U	X6S	X7R	X6S	
Cap. / TC Code	X7R	X7R	X7R	B	X5R	X7R	X7R	X7R	X7R	X7R	X7R	X5R, B	X7R	X5R, B	X7R	X6S	X5R, B	X7R	X5R, B	X7Δ	X6S	X5R, B	X7U	X6S	X7R	X6S	
100pF																											
150pF																											
220pF																											
330pF																											
470pF																											
680pF																											
820pF																											
1000pF																											
1500pF																											
2200pF																											
3300pF																											
4700pF																											
6800pF																											
10000pF																											
15000pF																											
22000pF																											
33000pF																											
47000pF																											
68000pF																											
0.10μF																											
0.15μF																											
0.22μF																											
0.33μF																											
0.47μF																											
0.68μF																											
1.0μF																											
2.2μF																											
4.7μF																											
10μF																											
22μF																											
47μF																											
100μF																											
150μF																											
220μF																											

Continued on the following page. ↗

Capacitance Table

p00 Each number in the Part Number List refers to the page number printed at the bottom of the page.

(→ GRM Series High Dielectric Constant Type)

p00 ← Part Number List JIS: R B EIA: X7R X7S X7T X7U X6S X6T X5R

L×W (mm)	3.2×1.6										3.2×2.5																	
	1.9										1.5					1.8	2.0					2.2		2.7				
T max. (mm)	1.9										1.5					1.8	2.0					2.2		2.7				
Rated Voltage (Vdc)	16	10	6.3	4			2.5			1000	630	500	250	200	100	1000	630	500	250	200	100	25	100	80	63	50		
Cap. / TC Code	X7S	X5R	X6S	X6T	X5R	X7U	X6Δ	X5R	X6S	X5R	X7R	X7R	X7R	X7R	X7R	X7R	X7R	X7R	X7R	X7R	X7S	X7R	X7R	X7R	X7R	X7R	X7R	
100pF																												
150pF																												
220pF																												
330pF																												
470pF																												
680pF																												
820pF																												
1000pF																												
1500pF																												
2200pF																												
3300pF																												
4700pF																												
6800pF																												
10000pF																												
15000pF																												
22000pF																												
33000pF																												
47000pF																												
68000pF																												
0.10μF																												
0.15μF																												
0.22μF																												
0.33μF																												
0.47μF																												
0.68μF																												
1.0μF																												
2.2μF																												
4.7μF																												
10μF																												
22μF																												
47μF																												
100μF																												
150μF																												
220μF																												

Continued on the following page. ↗

Search Capacitors

Specifications and Test Methods, Package, Chart of Characteristic Data, please refer to the search web page.
<http://www.murata.com/en-global/products/capacitor>

0.4×0.2mm						
T max.	Rated Voltage	TC Code	Cap.	Tol.	Part Number	
0.22mm	50Vdc	COG	0.20pF	±0.05pF	GRM0225C1HR20WA03#	
			0.30pF	±0.05pF	GRM0225C1HR20BA03#	
			0.40pF	±0.05pF	GRM0225C1HR30BA03#	
			0.50pF	±0.05pF	GRM0225C1HR50BA03#	
			0.60pF	±0.05pF	GRM0225C1HR60WA03#	

Links are provided to the product detail pages on the web, and are shown below in the product number table from the PDF version of the catalog which is available on the web.

Data Sheet

The product details page can be output in PDF.

Status and Features Icons

The status and features of products can be checked at once. When ? is clicked, a description of each icon will be displayed.

Characteristics & Applications

This links to the introduction page of each series.

Detailed Specifications Sheet

- Rated value
- Specifications and Test Methods
- Package
- Caution, Notice (Storage, Soldering and Mounting,etc.)

Characteristics Data

The following characteristics data of the main products can be acquired.

- SPICE Netlist (mod type)
- S parameter (S2P type)
- Reliability Test Data *Typical data

- Shape (Dimensions)
- Rated Values

- Specification by Packaging Code/ Minimum Order Quantity
- Weight (1 pc/ø180mm reel)

Chart of Characteristic Data

The main products published characteristic data.

- Frequency characteristics (ESR, Impedance)
- DC bias characteristics
- AC voltage characteristics
- Capacitance - temperature characteristics
- Calorific property by ripple current

Design Tools SimSurfing

The SimSurfing design tools are useful for displaying the graph, downloading CSV data and overwriting the product number graph.

General Purpose Monolithic Ceramic Capacitors

GRM Series



This is Murata primary products renowned for both small size and large capacitance value with latest advanced technology.

Features

① Achieves large-capacity and small size in a multilayer structure.

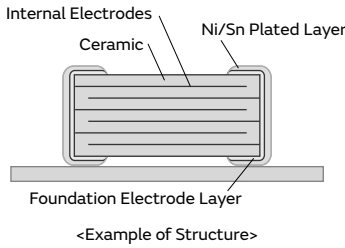

"Thin Layer Technology" for thinner layers

"Fine Particle Technology" for finer particles

"High Precision Lamination Technology" for more accuracy

ceramic thickness: 1µm
 Internal electrode thickness: 0.7µm

ceramic thickness: 0.5µm
 Internal electrode thickness: 0.4µm

② Sn plating is applied to the external electrodes; excellent solderability.

③ High reliability with no polarity.

	Ceramic Capacitors	Tantalum Capacitor	Aluminum Electrolytic Capacitor	Conductive Polymer Capacitor
Price	○	○	◎	○
Comparison between Impedance Frequency Characteristics	◎	△	△	○
Capacitance temperature characteristics	○	◎	○	○
DC breakdown voltage	◎	△	△	△
Polarity	No	Yes	Yes	Yes
Pulse response	◎	△	△	○
Allowable ripple current	◎	△	△	△
Reliability	◎	○	○	○
DC bias characteristics	△	◎	◎	◎

◎: Particularly excellent ○: Excellent △: Inferior

Specifications

Size (mm)	0.25×0.125mm to 5.7×5.0mm
Rated Voltage	2.5Vdc to 3150Vdc
Capacitance	0.10pF to 330µF
Main Applications	1. Rated voltage 100V Max. High Dielectric Constant Type . . . For decoupling and smoothing circuits Temperature Compensating Type . . . For tuning circuits, oscillating circuits, and high frequency filter circuits 2. Rated voltage 200V min. High Dielectric Constant Type . . . For clamp snubber circuits and smoothing circuits Temperature Compensating Type . . . Power supply damper snubber

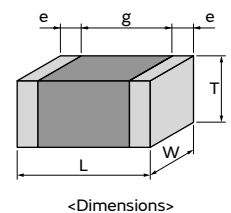

This catalog contains only a portion of the product lineup.
 Please refer to the capacitor search tool on the Murata Web site for details.

GRM Series
 GJM Series
 GMA Series
 GMD Series
 GQM Series
 GR3 Series
 GRJ Series
 LLA Series
 LLL Series
 LLM Series
 LLP Series
 KRM Series
 KR3 Series
 NFM Series
 GCH Series
 △Caution/ Notice

GRM Series Temperature Compensating Type Part Number List

(→ 0.6×0.3mm)

T max.	Rated Voltage	TC Code	Cap.	Tol.	Part Number	
0.33mm	50Vdc	CH	18pF	±2%	GRM0332C1H180GA01#	
				±5%	GRM0332C1H180JA01#	
			22pF	±2%	GRM0332C1H220GA01#	
				±5%	GRM0332C1H220JA01#	
			27pF	±2%	GRM0332C1H270GA01#	
				±5%	GRM0332C1H270JA01#	
			33pF	±2%	GRM0332C1H330GA01#	
				±5%	GRM0332C1H330JA01#	
			39pF	±2%	GRM0332C1H390GA01#	
				±5%	GRM0332C1H390JA01#	
			47pF	±2%	GRM0332C1H470GA01#	
				±5%	GRM0332C1H470JA01#	
			56pF	±2%	GRM0332C1H560GA01#	
				±5%	GRM0332C1H560JA01#	
			68pF	±2%	GRM0332C1H680GA01#	
				±5%	GRM0332C1H680JA01#	
			82pF	±2%	GRM0332C1H820GA01#	
				±5%	GRM0332C1H820JA01#	
			100pF	±2%	GRM0332C1H101GA01#	
				±5%	GRM0332C1H101JA01#	
			120pF	±2%	GRM0332C1H121GA01#	
				±5%	GRM0332C1H121JA01#	
			150pF	±2%	GRM0332C1H151GA01#	
				±5%	GRM0332C1H151JA01#	
	180pF	±2%	GRM0332C1H181GA01#			
		±5%	GRM0332C1H181JA01#			
	220pF	±2%	GRM0332C1H221GA01#			
		±5%	GRM0332C1H221JA01#			
	25Vdc	COG	270pF	±2%	GRM0335C1E271GA01#	
				±5%	GRM0335C1E271JA01#	
			330pF	±2%	GRM0335C1E331GA01#	
				±5%	GRM0335C1E331JA01#	
			390pF	±2%	GRM0335C1E391GA01#	
				±5%	GRM0335C1E391JA01#	
			470pF	±2%	GRM0335C1E471GA01#	
				±5%	GRM0335C1E471JA01#	
			560pF	±2%	GRM0335C1E561GA01#	
				±5%	GRM0335C1E561JA01#	
			680pF	±2%	GRM0335C1E681GA01#	
				±5%	GRM0335C1E681JA01#	
			820pF	±2%	GRM0335C1E821GA01#	
				±5%	GRM0335C1E821JA01#	
			910pF	±2%	GRM0335C1E911GA01#	
				±5%	GRM0335C1E911JA01#	
			1000pF	±2%	GRM0335C1E102GA01#	
				±5%	GRM0335C1E102JA01#	
			CH	270pF	±2%	GRM0332C1E271GA01#
					±5%	GRM0332C1E271JA01#
330pF				±2%	GRM0332C1E331GA01#	
				±5%	GRM0332C1E331JA01#	
390pF				±2%	GRM0332C1E391GA01#	
				±5%	GRM0332C1E391JA01#	
470pF	±2%	GRM0332C1E471GA01#				
	±5%	GRM0332C1E471JA01#				

T max.	Rated Voltage	TC Code	Cap.	Tol.	Part Number
0.33mm	25Vdc	CH	560pF	±2%	GRM0332C1E561GA01#
				±5%	GRM0332C1E561JA01#
			680pF	±2%	GRM0332C1E681GA01#
				±5%	GRM0332C1E681JA01#
			820pF	±2%	GRM0332C1E821GA01#
				±5%	GRM0332C1E821JA01#
			1000pF	±2%	GRM0332C1E102GA01#
				±5%	GRM0332C1E102JA01#

1.0×0.5mm

T max.	Rated Voltage	TC Code	Cap.	Tol.	Part Number
0.55mm	100Vdc	COG	0.10pF	±0.05pF	GRM1555C2AR10WA01#
				±0.1pF	GRM1555C2AR20BA01#
			0.20pF	±0.05pF	GRM1555C2AR20WA01#
				±0.1pF	GRM1555C2AR20BA01#
			0.30pF	±0.05pF	GRM1555C2AR30WA01#
				±0.1pF	GRM1555C2AR30BA01#
			0.40pF	±0.05pF	GRM1555C2AR40WA01#
				±0.1pF	GRM1555C2AR40BA01#
			0.50pF	±0.05pF	GRM1555C2AR50WA01#
				±0.1pF	GRM1555C2AR50BA01#
			0.60pF	±0.05pF	GRM1555C2AR60WA01#
				±0.1pF	GRM1555C2AR60BA01#
			0.70pF	±0.05pF	GRM1555C2AR70WA01#
				±0.1pF	GRM1555C2AR70BA01#
			0.80pF	±0.05pF	GRM1555C2AR80WA01#
				±0.1pF	GRM1555C2AR80BA01#
			0.90pF	±0.05pF	GRM1555C2AR90WA01#
				±0.1pF	GRM1555C2AR90BA01#
			1.0pF	±0.05pF	GRM1555C2A1R0WA01#
				±0.1pF	GRM1555C2A1R0BA01#
				±0.25pF	GRM1555C2A1R0CA01#
			1.1pF	±0.05pF	GRM1555C2A1R1WA01#
				±0.1pF	GRM1555C2A1R1BA01#
				±0.25pF	GRM1555C2A1R1CA01#
			1.2pF	±0.05pF	GRM1555C2A1R2WA01#
				±0.1pF	GRM1555C2A1R2BA01#
				±0.25pF	GRM1555C2A1R2CA01#
			1.3pF	±0.05pF	GRM1555C2A1R3WA01#
				±0.1pF	GRM1555C2A1R3BA01#
				±0.25pF	GRM1555C2A1R3CA01#
			1.4pF	±0.05pF	GRM1555C2A1R4WA01#
				±0.1pF	GRM1555C2A1R4BA01#
				±0.25pF	GRM1555C2A1R4CA01#
			1.5pF	±0.05pF	GRM1555C2A1R5WA01#
				±0.1pF	GRM1555C2A1R5BA01#
				±0.25pF	GRM1555C2A1R5CA01#
			1.6pF	±0.05pF	GRM1555C2A1R6WA01#
				±0.1pF	GRM1555C2A1R6BA01#
				±0.25pF	GRM1555C2A1R6CA01#
			1.7pF	±0.05pF	GRM1555C2A1R7WA01#
				±0.1pF	GRM1555C2A1R7BA01#
				±0.25pF	GRM1555C2A1R7CA01#

Part number # indicates the package specification code.

GRM Series
 GJM Series
 GVA Series
 GMD Series
 GOM Series
 GR3 Series
 GRJ Series
 LLA Series
 LLL Series
 LLLM Series
 LLR Series
 KRM Series
 KR3 Series
 NFM Series
 GCH Series
 ⚠Caution/Notice

GRM Series Temperature Compensating Type Part Number List

(→ 1.0×0.5mm)

T max.	Rated Voltage	TC Code	Cap.	Tol.	Part Number	T max.	Rated Voltage	TC Code	Cap.	Tol.	Part Number
0.55mm	100Vdc	COG	1.8pF	±0.05pF	GRM1555C2A1R8WA01#	0.55mm	100Vdc	COG	3.6pF	±0.05pF	GRM1555C2A3R6WA01#
				±0.1pF	GRM1555C2A1R8BA01#					±0.1pF	GRM1555C2A3R6BA01#
				±0.25pF	GRM1555C2A1R8CA01#					±0.25pF	GRM1555C2A3R6CA01#
			1.9pF	±0.05pF	GRM1555C2A1R9WA01#				3.7pF	±0.05pF	GRM1555C2A3R7WA01#
				±0.1pF	GRM1555C2A1R9BA01#					±0.1pF	GRM1555C2A3R7BA01#
				±0.25pF	GRM1555C2A1R9CA01#					±0.25pF	GRM1555C2A3R7CA01#
			2.0pF	±0.05pF	GRM1555C2A2R0WA01#				3.8pF	±0.05pF	GRM1555C2A3R8WA01#
				±0.1pF	GRM1555C2A2R0BA01#					±0.1pF	GRM1555C2A3R8BA01#
				±0.25pF	GRM1555C2A2R0CA01#					±0.25pF	GRM1555C2A3R8CA01#
			2.1pF	±0.05pF	GRM1555C2A2R1WA01#				3.9pF	±0.05pF	GRM1555C2A3R9WA01#
				±0.1pF	GRM1555C2A2R1BA01#					±0.1pF	GRM1555C2A3R9BA01#
				±0.25pF	GRM1555C2A2R1CA01#					±0.25pF	GRM1555C2A3R9CA01#
			2.2pF	±0.05pF	GRM1555C2A2R2WA01#				4.0pF	±0.05pF	GRM1555C2A4R0WA01#
				±0.1pF	GRM1555C2A2R2BA01#					±0.1pF	GRM1555C2A4R0BA01#
				±0.25pF	GRM1555C2A2R2CA01#					±0.25pF	GRM1555C2A4R0CA01#
			2.3pF	±0.05pF	GRM1555C2A2R3WA01#				4.1pF	±0.05pF	GRM1555C2A4R1WA01#
				±0.1pF	GRM1555C2A2R3BA01#					±0.1pF	GRM1555C2A4R1BA01#
				±0.25pF	GRM1555C2A2R3CA01#					±0.25pF	GRM1555C2A4R1CA01#
			2.4pF	±0.05pF	GRM1555C2A2R4WA01#				4.2pF	±0.05pF	GRM1555C2A4R2WA01#
				±0.1pF	GRM1555C2A2R4BA01#					±0.1pF	GRM1555C2A4R2BA01#
				±0.25pF	GRM1555C2A2R4CA01#					±0.25pF	GRM1555C2A4R2CA01#
			2.5pF	±0.05pF	GRM1555C2A2R5WA01#				4.3pF	±0.05pF	GRM1555C2A4R3WA01#
				±0.1pF	GRM1555C2A2R5BA01#					±0.1pF	GRM1555C2A4R3BA01#
				±0.25pF	GRM1555C2A2R5CA01#					±0.25pF	GRM1555C2A4R3CA01#
			2.6pF	±0.05pF	GRM1555C2A2R6WA01#				4.4pF	±0.05pF	GRM1555C2A4R4WA01#
				±0.1pF	GRM1555C2A2R6BA01#					±0.1pF	GRM1555C2A4R4BA01#
				±0.25pF	GRM1555C2A2R6CA01#					±0.25pF	GRM1555C2A4R4CA01#
			2.7pF	±0.05pF	GRM1555C2A2R7WA01#				4.5pF	±0.05pF	GRM1555C2A4R5WA01#
				±0.1pF	GRM1555C2A2R7BA01#					±0.1pF	GRM1555C2A4R5BA01#
				±0.25pF	GRM1555C2A2R7CA01#					±0.25pF	GRM1555C2A4R5CA01#
			2.8pF	±0.05pF	GRM1555C2A2R8WA01#				4.6pF	±0.05pF	GRM1555C2A4R6WA01#
				±0.1pF	GRM1555C2A2R8BA01#					±0.1pF	GRM1555C2A4R6BA01#
				±0.25pF	GRM1555C2A2R8CA01#					±0.25pF	GRM1555C2A4R6CA01#
			2.9pF	±0.05pF	GRM1555C2A2R9WA01#				4.7pF	±0.05pF	GRM1555C2A4R7WA01#
				±0.1pF	GRM1555C2A2R9BA01#					±0.1pF	GRM1555C2A4R7BA01#
				±0.25pF	GRM1555C2A2R9CA01#					±0.25pF	GRM1555C2A4R7CA01#
			3.0pF	±0.05pF	GRM1555C2A3R0WA01#				4.8pF	±0.05pF	GRM1555C2A4R8WA01#
				±0.1pF	GRM1555C2A3R0BA01#					±0.1pF	GRM1555C2A4R8BA01#
				±0.25pF	GRM1555C2A3R0CA01#					±0.25pF	GRM1555C2A4R8CA01#
			3.1pF	±0.05pF	GRM1555C2A3R1WA01#				4.9pF	±0.05pF	GRM1555C2A4R9WA01#
				±0.1pF	GRM1555C2A3R1BA01#					±0.1pF	GRM1555C2A4R9BA01#
				±0.25pF	GRM1555C2A3R1CA01#					±0.25pF	GRM1555C2A4R9CA01#
			3.2pF	±0.05pF	GRM1555C2A3R2WA01#				5.0pF	±0.05pF	GRM1555C2A5R0WA01#
				±0.1pF	GRM1555C2A3R2BA01#					±0.1pF	GRM1555C2A5R0BA01#
				±0.25pF	GRM1555C2A3R2CA01#					±0.25pF	GRM1555C2A5R0CA01#
3.3pF	±0.05pF	GRM1555C2A3R3WA01#	5.1pF	±0.05pF	GRM1555C2A5R1WA01#						
	±0.1pF	GRM1555C2A3R3BA01#		±0.1pF	GRM1555C2A5R1BA01#						
	±0.25pF	GRM1555C2A3R3CA01#		±0.25pF	GRM1555C2A5R1CA01#						
3.4pF	±0.05pF	GRM1555C2A3R4WA01#	5.2pF	±0.05pF	GRM1555C2A5R2WA01#						
	±0.1pF	GRM1555C2A3R4BA01#		±0.1pF	GRM1555C2A5R2BA01#						
	±0.25pF	GRM1555C2A3R4CA01#		±0.25pF	GRM1555C2A5R2CA01#						
3.5pF	±0.05pF	GRM1555C2A3R5WA01#	5.3pF	±0.05pF	GRM1555C2A5R3WA01#						
	±0.1pF	GRM1555C2A3R5BA01#		±0.1pF	GRM1555C2A5R3BA01#						
	±0.25pF	GRM1555C2A3R5CA01#		±0.25pF	GRM1555C2A5R3CA01#						

Part number # indicates the package specification code.

GRM Series Temperature Compensating Type Part Number List

(→ 1.0×0.5mm)

T max.	Rated Voltage	TC Code	Cap.	Tol.	Part Number	T max.	Rated Voltage	TC Code	Cap.	Tol.	Part Number
0.55mm	100Vdc	COG	5.3pF	±0.1pF	GRM1555C2A5R3BA01#	0.55mm	100Vdc	COG	6.6pF	±0.5pF	GRM1555C2A6R6DA01#
				±0.25pF	GRM1555C2A5R3CA01#					±0.5pF	GRM1555C2A6R7WA01#
				±0.5pF	GRM1555C2A5R3DA01#					±0.1pF	GRM1555C2A6R7BA01#
			5.4pF	±0.05pF	GRM1555C2A5R4WA01#				±0.25pF	GRM1555C2A6R7CA01#	
				±0.1pF	GRM1555C2A5R4BA01#				±0.5pF	GRM1555C2A6R7DA01#	
				±0.25pF	GRM1555C2A5R4CA01#				6.8pF	±0.05pF	GRM1555C2A6R8WA01#
			±0.5pF	GRM1555C2A5R4DA01#	±0.1pF					GRM1555C2A6R8BA01#	
			5.5pF	±0.05pF	GRM1555C2A5R5WA01#					±0.25pF	GRM1555C2A6R8CA01#
				±0.1pF	GRM1555C2A5R5BA01#				±0.5pF	GRM1555C2A6R8DA01#	
				±0.25pF	GRM1555C2A5R5CA01#				6.9pF	±0.05pF	GRM1555C2A6R9WA01#
			±0.5pF	GRM1555C2A5R5DA01#	±0.1pF					GRM1555C2A6R9BA01#	
			5.6pF	±0.05pF	GRM1555C2A5R6WA01#					±0.25pF	GRM1555C2A6R9CA01#
				±0.1pF	GRM1555C2A5R6BA01#				±0.5pF	GRM1555C2A6R9DA01#	
				±0.25pF	GRM1555C2A5R6CA01#				7.0pF	±0.05pF	GRM1555C2A7R0WA01#
			±0.5pF	GRM1555C2A5R6DA01#	±0.1pF					GRM1555C2A7R0BA01#	
			5.7pF	±0.05pF	GRM1555C2A5R7WA01#					±0.25pF	GRM1555C2A7R0CA01#
				±0.1pF	GRM1555C2A5R7BA01#				±0.5pF	GRM1555C2A7R0DA01#	
				±0.25pF	GRM1555C2A5R7CA01#				7.1pF	±0.05pF	GRM1555C2A7R1WA01#
			±0.5pF	GRM1555C2A5R7DA01#	±0.1pF					GRM1555C2A7R1BA01#	
			5.8pF	±0.05pF	GRM1555C2A5R8WA01#					±0.25pF	GRM1555C2A7R1CA01#
				±0.1pF	GRM1555C2A5R8BA01#				±0.5pF	GRM1555C2A7R1DA01#	
				±0.25pF	GRM1555C2A5R8CA01#				7.2pF	±0.05pF	GRM1555C2A7R2WA01#
			±0.5pF	GRM1555C2A5R8DA01#	±0.1pF					GRM1555C2A7R2BA01#	
			5.9pF	±0.05pF	GRM1555C2A5R9WA01#					±0.25pF	GRM1555C2A7R2CA01#
				±0.1pF	GRM1555C2A5R9BA01#				±0.5pF	GRM1555C2A7R2DA01#	
				±0.25pF	GRM1555C2A5R9CA01#				7.3pF	±0.05pF	GRM1555C2A7R3WA01#
			±0.5pF	GRM1555C2A5R9DA01#	±0.1pF					GRM1555C2A7R3BA01#	
			6.0pF	±0.05pF	GRM1555C2A6R0WA01#					±0.25pF	GRM1555C2A7R3CA01#
				±0.1pF	GRM1555C2A6R0BA01#				±0.5pF	GRM1555C2A7R3DA01#	
				±0.25pF	GRM1555C2A6R0CA01#				7.4pF	±0.05pF	GRM1555C2A7R4WA01#
			±0.5pF	GRM1555C2A6R0DA01#	±0.1pF					GRM1555C2A7R4BA01#	
			6.1pF	±0.05pF	GRM1555C2A6R1WA01#					±0.25pF	GRM1555C2A7R4CA01#
				±0.1pF	GRM1555C2A6R1BA01#				±0.5pF	GRM1555C2A7R4DA01#	
				±0.25pF	GRM1555C2A6R1CA01#				7.5pF	±0.05pF	GRM1555C2A7R5WA01#
			±0.5pF	GRM1555C2A6R1DA01#	±0.1pF					GRM1555C2A7R5BA01#	
			6.2pF	±0.05pF	GRM1555C2A6R2WA01#					±0.25pF	GRM1555C2A7R5CA01#
				±0.1pF	GRM1555C2A6R2BA01#				±0.5pF	GRM1555C2A7R5DA01#	
				±0.25pF	GRM1555C2A6R2CA01#				7.6pF	±0.05pF	GRM1555C2A7R6WA01#
			±0.5pF	GRM1555C2A6R2DA01#	±0.1pF					GRM1555C2A7R6BA01#	
			6.3pF	±0.05pF	GRM1555C2A6R3WA01#					±0.25pF	GRM1555C2A7R6CA01#
				±0.1pF	GRM1555C2A6R3BA01#				±0.5pF	GRM1555C2A7R6DA01#	
				±0.25pF	GRM1555C2A6R3CA01#				7.7pF	±0.05pF	GRM1555C2A7R7WA01#
			±0.5pF	GRM1555C2A6R3DA01#	±0.1pF					GRM1555C2A7R7BA01#	
			6.4pF	±0.05pF	GRM1555C2A6R4WA01#					±0.25pF	GRM1555C2A7R7CA01#
				±0.1pF	GRM1555C2A6R4BA01#				±0.5pF	GRM1555C2A7R7DA01#	
				±0.25pF	GRM1555C2A6R4CA01#				7.8pF	±0.05pF	GRM1555C2A7R8WA01#
			±0.5pF	GRM1555C2A6R4DA01#	±0.1pF					GRM1555C2A7R8BA01#	
			6.5pF	±0.05pF	GRM1555C2A6R5WA01#					±0.25pF	GRM1555C2A7R8CA01#
				±0.1pF	GRM1555C2A6R5BA01#				±0.5pF	GRM1555C2A7R8DA01#	
				±0.25pF	GRM1555C2A6R5CA01#				7.9pF	±0.05pF	GRM1555C2A7R9WA01#
			±0.5pF	GRM1555C2A6R5DA01#	±0.1pF					GRM1555C2A7R9BA01#	
			6.6pF	±0.05pF	GRM1555C2A6R6WA01#					±0.25pF	GRM1555C2A7R9CA01#
				±0.1pF	GRM1555C2A6R6BA01#				±0.5pF	GRM1555C2A7R9DA01#	
				±0.25pF	GRM1555C2A6R6CA01#				8.0pF	±0.05pF	GRM1555C2A8R0WA01#

Part number # indicates the package specification code.

GRM Series
 GJM Series
 GMA Series
 GMD Series
 GQM Series
 GR3 Series
 GRJ Series
 LLA Series
 LLL Series
 LLM Series
 LLR Series
 KRM Series
 KR3 Series
 NFM Series
 GCH Series
 ⚠Caution/ Notice

GRM Series Temperature Compensating Type Part Number List

(→ 1.0×0.5mm)

T max.	Rated Voltage	TC Code	Cap.	Tol.	Part Number	T max.	Rated Voltage	TC Code	Cap.	Tol.	Part Number
0.55mm	100Vdc	COG	8.0pF	±0.1pF	GRM1555C2A8R0BA01#	0.55mm	100Vdc	COG	9.3pF	±0.5pF	GRM1555C2A9R3DA01#
				±0.25pF	GRM1555C2A8R0CA01#					±0.05pF	GRM1555C2A9R4WA01#
				±0.5pF	GRM1555C2A8R0DA01#					±0.1pF	GRM1555C2A9R4BA01#
			8.1pF	±0.05pF	GRM1555C2A8R1WA01#				±0.25pF	GRM1555C2A9R4CA01#	
				±0.1pF	GRM1555C2A8R1BA01#				±0.5pF	GRM1555C2A9R4DA01#	
				±0.25pF	GRM1555C2A8R1CA01#				9.5pF	±0.05pF	GRM1555C2A9R5WA01#
			±0.5pF	GRM1555C2A8R1DA01#	±0.1pF					GRM1555C2A9R5BA01#	
			8.2pF	±0.05pF	GRM1555C2A8R2WA01#					±0.25pF	GRM1555C2A9R5CA01#
				±0.1pF	GRM1555C2A8R2BA01#				±0.5pF	GRM1555C2A9R5DA01#	
				±0.25pF	GRM1555C2A8R2CA01#				9.6pF	±0.05pF	GRM1555C2A9R6WA01#
			±0.5pF	GRM1555C2A8R2DA01#	±0.1pF					GRM1555C2A9R6BA01#	
			8.3pF	±0.05pF	GRM1555C2A8R3WA01#					±0.25pF	GRM1555C2A9R6CA01#
				±0.1pF	GRM1555C2A8R3BA01#				±0.5pF	GRM1555C2A9R6DA01#	
				±0.25pF	GRM1555C2A8R3CA01#				9.7pF	±0.05pF	GRM1555C2A9R7WA01#
			±0.5pF	GRM1555C2A8R3DA01#	±0.1pF					GRM1555C2A9R7BA01#	
			8.4pF	±0.05pF	GRM1555C2A8R4WA01#					±0.25pF	GRM1555C2A9R7CA01#
				±0.1pF	GRM1555C2A8R4BA01#				±0.5pF	GRM1555C2A9R7DA01#	
				±0.25pF	GRM1555C2A8R4CA01#				9.8pF	±0.05pF	GRM1555C2A9R8WA01#
			±0.5pF	GRM1555C2A8R4DA01#	±0.1pF					GRM1555C2A9R8BA01#	
			8.5pF	±0.05pF	GRM1555C2A8R5WA01#					±0.25pF	GRM1555C2A9R8CA01#
				±0.1pF	GRM1555C2A8R5BA01#				±0.5pF	GRM1555C2A9R8DA01#	
				±0.25pF	GRM1555C2A8R5CA01#				9.9pF	±0.05pF	GRM1555C2A9R9WA01#
			±0.5pF	GRM1555C2A8R5DA01#	±0.1pF					GRM1555C2A9R9BA01#	
			8.6pF	±0.05pF	GRM1555C2A8R6WA01#					±0.25pF	GRM1555C2A9R9CA01#
				±0.1pF	GRM1555C2A8R6BA01#				±0.5pF	GRM1555C2A9R9DA01#	
				±0.25pF	GRM1555C2A8R6CA01#				10pF	±2%	GRM1555C2A100GA01#
			±0.5pF	GRM1555C2A8R6DA01#	±5%					GRM1555C2A100JA01#	
			8.7pF	±0.05pF	GRM1555C2A8R7WA01#					12pF	±2%
				±0.1pF	GRM1555C2A8R7BA01#				±5%		GRM1555C2A120JA01#
				±0.25pF	GRM1555C2A8R7CA01#				15pF		±2%
			±0.5pF	GRM1555C2A8R7DA01#	±5%					GRM1555C2A150JA01#	
			8.8pF	±0.05pF	GRM1555C2A8R8WA01#					18pF	±2%
				±0.1pF	GRM1555C2A8R8BA01#				±5%		GRM1555C2A180JA01#
				±0.25pF	GRM1555C2A8R8CA01#				22pF		±2%
			±0.5pF	GRM1555C2A8R8DA01#	±5%					GRM1555C2A220JA01#	
			8.9pF	±0.05pF	GRM1555C2A8R9WA01#					27pF	±2%
				±0.1pF	GRM1555C2A8R9BA01#				±5%		GRM1555C2A270JA01#
				±0.25pF	GRM1555C2A8R9CA01#				33pF		±2%
			±0.5pF	GRM1555C2A8R9DA01#	±5%					GRM1555C2A330JA01#	
			9.0pF	±0.05pF	GRM1555C2A9R0WA01#					39pF	±2%
				±0.1pF	GRM1555C2A9R0BA01#				±5%		GRM1555C2A390JA01#
				±0.25pF	GRM1555C2A9R0CA01#				47pF		±2%
			±0.5pF	GRM1555C2A9R0DA01#	±5%					GRM1555C2A470JA01#	
			9.1pF	±0.05pF	GRM1555C2A9R1WA01#					56pF	±2%
				±0.1pF	GRM1555C2A9R1BA01#				±5%		GRM1555C2A560JA01#
				±0.25pF	GRM1555C2A9R1CA01#				68pF		±2%
			±0.5pF	GRM1555C2A9R1DA01#	±5%					GRM1555C2A680JA01#	
			9.2pF	±0.05pF	GRM1555C2A9R2WA01#					82pF	±2%
				±0.1pF	GRM1555C2A9R2BA01#				±5%		GRM1555C2A820JA01#
				±0.25pF	GRM1555C2A9R2CA01#				100pF		±2%
			±0.5pF	GRM1555C2A9R2DA01#	±5%					GRM1555C2A101JA01#	
			9.3pF	±0.05pF	GRM1555C2A9R3WA01#					CK	±0.05pF
				±0.1pF	GRM1555C2A9R3BA01#				±0.05pF		GRM1554C2AR20WA01#
				±0.25pF	GRM1555C2A9R3CA01#				±0.1pF		GRM1554C2AR20BA01#

Part number # indicates the package specification code.

⚠Caution/
Notice

GRM Series
GJM Series
GMA Series
GMD Series
GQM Series
GR3 Series
GRJ Series
LLA Series
LLL Series
LLM Series
LLP Series
KRM Series
KR3 Series
NFM Series
GCH Series

GRM Series Temperature Compensating Type Part Number List

(→ 1.0×0.5mm)

T max.	Rated Voltage	TC Code	Cap.	Tol.	Part Number	T max.	Rated Voltage	TC Code	Cap.	Tol.	Part Number
0.55mm	100Vdc	CK	0.30pF	±0.05pF	GRM1554C2AR30WA01#	0.55mm	100Vdc	CJ	2.3pF	±0.1pF	GRM1553C2A2R3BA01#
				±0.1pF	GRM1554C2AR30BA01#					±0.25pF	GRM1553C2A2R3CA01#
			0.40pF	±0.05pF	GRM1554C2AR40WA01#				2.4pF	±0.05pF	GRM1553C2A2R4WA01#
				±0.1pF	GRM1554C2AR40BA01#					±0.1pF	GRM1553C2A2R4BA01#
			0.50pF	±0.05pF	GRM1554C2AR50WA01#				2.5pF	±0.25pF	GRM1553C2A2R4CA01#
				±0.1pF	GRM1554C2AR50BA01#					±0.05pF	GRM1553C2A2R5WA01#
			0.60pF	±0.05pF	GRM1554C2AR60WA01#				2.6pF	±0.1pF	GRM1553C2A2R5BA01#
				±0.1pF	GRM1554C2AR60BA01#					±0.25pF	GRM1553C2A2R5CA01#
			0.70pF	±0.05pF	GRM1554C2AR70WA01#				2.7pF	±0.05pF	GRM1553C2A2R6WA01#
				±0.1pF	GRM1554C2AR70BA01#					±0.1pF	GRM1553C2A2R6BA01#
			0.80pF	±0.05pF	GRM1554C2AR80WA01#				2.8pF	±0.25pF	GRM1553C2A2R6CA01#
				±0.1pF	GRM1554C2AR80BA01#					±0.05pF	GRM1553C2A2R7WA01#
			0.90pF	±0.05pF	GRM1554C2AR90WA01#				2.9pF	±0.1pF	GRM1553C2A2R7BA01#
				±0.1pF	GRM1554C2AR90BA01#					±0.25pF	GRM1553C2A2R7CA01#
			1.0pF	±0.05pF	GRM1554C2A1R0WA01#				3.0pF	±0.05pF	GRM1553C2A2R8WA01#
				±0.1pF	GRM1554C2A1R0BA01#					±0.1pF	GRM1553C2A2R8BA01#
				±0.25pF	GRM1554C2A1R0CA01#					±0.25pF	GRM1553C2A2R8CA01#
			1.1pF	±0.05pF	GRM1554C2A1R1WA01#				3.1pF	±0.05pF	GRM1553C2A2R9WA01#
				±0.1pF	GRM1554C2A1R1BA01#					±0.1pF	GRM1553C2A2R9BA01#
				±0.25pF	GRM1554C2A1R1CA01#					±0.25pF	GRM1553C2A2R9CA01#
			1.2pF	±0.05pF	GRM1554C2A1R2WA01#				3.2pF	±0.05pF	GRM1553C2A3R0WA01#
				±0.1pF	GRM1554C2A1R2BA01#					±0.1pF	GRM1553C2A3R0BA01#
				±0.25pF	GRM1554C2A1R2CA01#					±0.25pF	GRM1553C2A3R0CA01#
			1.3pF	±0.05pF	GRM1554C2A1R3WA01#				3.3pF	±0.05pF	GRM1553C2A3R1WA01#
				±0.1pF	GRM1554C2A1R3BA01#					±0.1pF	GRM1553C2A3R1BA01#
				±0.25pF	GRM1554C2A1R3CA01#					±0.25pF	GRM1553C2A3R1CA01#
			1.4pF	±0.05pF	GRM1554C2A1R4WA01#				3.4pF	±0.05pF	GRM1553C2A3R2WA01#
				±0.1pF	GRM1554C2A1R4BA01#					±0.1pF	GRM1553C2A3R2BA01#
				±0.25pF	GRM1554C2A1R4CA01#					±0.25pF	GRM1553C2A3R2CA01#
			1.5pF	±0.05pF	GRM1554C2A1R5WA01#				3.5pF	±0.05pF	GRM1553C2A3R3WA01#
				±0.1pF	GRM1554C2A1R5BA01#					±0.1pF	GRM1553C2A3R3BA01#
				±0.25pF	GRM1554C2A1R5CA01#					±0.25pF	GRM1553C2A3R3CA01#
			1.6pF	±0.05pF	GRM1554C2A1R6WA01#				3.6pF	±0.05pF	GRM1553C2A3R4WA01#
				±0.1pF	GRM1554C2A1R6BA01#					±0.1pF	GRM1553C2A3R4BA01#
				±0.25pF	GRM1554C2A1R6CA01#					±0.25pF	GRM1553C2A3R4CA01#
			1.7pF	±0.05pF	GRM1554C2A1R7WA01#				3.7pF	±0.05pF	GRM1553C2A3R5WA01#
		±0.1pF		GRM1554C2A1R7BA01#	±0.1pF			GRM1553C2A3R5BA01#			
		±0.25pF		GRM1554C2A1R7CA01#	±0.25pF			GRM1553C2A3R5CA01#			
		1.8pF	±0.05pF	GRM1554C2A1R8WA01#	3.8pF			±0.05pF	GRM1553C2A3R6WA01#		
			±0.1pF	GRM1554C2A1R8BA01#				±0.1pF	GRM1553C2A3R6BA01#		
			±0.25pF	GRM1554C2A1R8CA01#				±0.25pF	GRM1553C2A3R6CA01#		
		1.9pF	±0.05pF	GRM1554C2A1R9WA01#	3.9pF			±0.05pF	GRM1553C2A3R7WA01#		
			±0.1pF	GRM1554C2A1R9BA01#				±0.1pF	GRM1553C2A3R7BA01#		
			±0.25pF	GRM1554C2A1R9CA01#				±0.25pF	GRM1553C2A3R7CA01#		
		2.0pF	±0.05pF	GRM1554C2A2R0WA01#	4.0pF			±0.05pF	GRM1552C2A4R0WA01#		
			±0.1pF	GRM1554C2A2R0BA01#				±0.1pF	GRM1552C2A4R0BA01#		
			±0.25pF	GRM1554C2A2R0CA01#				±0.25pF	GRM1552C2A4R0CA01#		
		2.1pF	±0.05pF	GRM1553C2A2R1WA01#	4.1pF			±0.05pF	GRM1552C2A4R1WA01#		
			±0.1pF	GRM1553C2A2R1BA01#							
			±0.25pF	GRM1553C2A2R1CA01#							
		2.2pF	±0.05pF	GRM1553C2A2R2WA01#							
			±0.1pF	GRM1553C2A2R2BA01#							
			±0.25pF	GRM1553C2A2R2CA01#							
		2.3pF	±0.05pF	GRM1553C2A2R3WA01#							

Part number # indicates the package specification code.

GRM Series
 GJM Series
 GVA Series
 GMD Series
 GQM Series
 GR3 Series
 GRJ Series
 LLA Series
 LLL Series
 LLM Series
 LLR Series
 KRM Series
 KR3 Series
 NFM Series
 GCH Series
 ⚠Caution/ Notice

GRM Series Temperature Compensating Type Part Number List

(→ 1.0×0.5mm)

T max.	Rated Voltage	TC Code	Cap.	Tol.	Part Number	T max.	Rated Voltage	TC Code	Cap.	Tol.	Part Number
0.55mm	100Vdc	CH	4.1pF	±0.1pF	GRM1552C2A4R1BA01#	0.55mm	100Vdc	CH	5.7pF	±0.1pF	GRM1552C2A5R7BA01#
				±0.25pF	GRM1552C2A4R1CA01#					±0.25pF	GRM1552C2A5R7CA01#
			4.2pF	±0.05pF	GRM1552C2A4R2WA01#	5.8pF	±0.05pF	GRM1552C2A5R8WA01#			
				±0.1pF	GRM1552C2A4R2BA01#		±0.1pF	GRM1552C2A5R8BA01#			
				±0.25pF	GRM1552C2A4R2CA01#		±0.25pF	GRM1552C2A5R8CA01#			
			4.3pF	±0.05pF	GRM1552C2A4R3WA01#	5.9pF	±0.05pF	GRM1552C2A5R9WA01#			
				±0.1pF	GRM1552C2A4R3BA01#		±0.1pF	GRM1552C2A5R9BA01#			
				±0.25pF	GRM1552C2A4R3CA01#		±0.25pF	GRM1552C2A5R9CA01#			
			4.4pF	±0.05pF	GRM1552C2A4R4WA01#	6.0pF	±0.05pF	GRM1552C2A6R0WA01#			
				±0.1pF	GRM1552C2A4R4BA01#		±0.1pF	GRM1552C2A6R0BA01#			
				±0.25pF	GRM1552C2A4R4CA01#		±0.25pF	GRM1552C2A6R0CA01#			
			4.5pF	±0.05pF	GRM1552C2A4R5WA01#	6.1pF	±0.05pF	GRM1552C2A6R1WA01#			
				±0.1pF	GRM1552C2A4R5BA01#		±0.1pF	GRM1552C2A6R1BA01#			
				±0.25pF	GRM1552C2A4R5CA01#		±0.25pF	GRM1552C2A6R1CA01#			
			4.6pF	±0.05pF	GRM1552C2A4R6WA01#	6.2pF	±0.05pF	GRM1552C2A6R2WA01#			
				±0.1pF	GRM1552C2A4R6BA01#		±0.1pF	GRM1552C2A6R2BA01#			
				±0.25pF	GRM1552C2A4R6CA01#		±0.25pF	GRM1552C2A6R2CA01#			
			4.7pF	±0.05pF	GRM1552C2A4R7WA01#	6.3pF	±0.05pF	GRM1552C2A6R3WA01#			
				±0.1pF	GRM1552C2A4R7BA01#		±0.1pF	GRM1552C2A6R3BA01#			
				±0.25pF	GRM1552C2A4R7CA01#		±0.25pF	GRM1552C2A6R3CA01#			
			4.8pF	±0.05pF	GRM1552C2A4R8WA01#	6.4pF	±0.05pF	GRM1552C2A6R4WA01#			
				±0.1pF	GRM1552C2A4R8BA01#		±0.1pF	GRM1552C2A6R4BA01#			
				±0.25pF	GRM1552C2A4R8CA01#		±0.25pF	GRM1552C2A6R4CA01#			
			4.9pF	±0.05pF	GRM1552C2A4R9WA01#	6.5pF	±0.05pF	GRM1552C2A6R5WA01#			
				±0.1pF	GRM1552C2A4R9BA01#		±0.1pF	GRM1552C2A6R5BA01#			
				±0.25pF	GRM1552C2A4R9CA01#		±0.25pF	GRM1552C2A6R5CA01#			
			5.0pF	±0.05pF	GRM1552C2A5R0WA01#	6.6pF	±0.05pF	GRM1552C2A6R6WA01#			
				±0.1pF	GRM1552C2A5R0BA01#		±0.1pF	GRM1552C2A6R6BA01#			
				±0.25pF	GRM1552C2A5R0CA01#		±0.25pF	GRM1552C2A6R6CA01#			
			5.1pF	±0.05pF	GRM1552C2A5R1WA01#	6.7pF	±0.05pF	GRM1552C2A6R7WA01#			
				±0.1pF	GRM1552C2A5R1BA01#		±0.1pF	GRM1552C2A6R7BA01#			
				±0.25pF	GRM1552C2A5R1CA01#		±0.25pF	GRM1552C2A6R7CA01#			
				±0.5pF	GRM1552C2A5R1DA01#		±0.5pF	GRM1552C2A6R7DA01#			
			5.2pF	±0.05pF	GRM1552C2A5R2WA01#	6.8pF	±0.05pF	GRM1552C2A6R8WA01#			
				±0.1pF	GRM1552C2A5R2BA01#		±0.1pF	GRM1552C2A6R8BA01#			
				±0.25pF	GRM1552C2A5R2CA01#		±0.25pF	GRM1552C2A6R8CA01#			
				±0.5pF	GRM1552C2A5R2DA01#		±0.5pF	GRM1552C2A6R8DA01#			
			5.3pF	±0.05pF	GRM1552C2A5R3WA01#	6.9pF	±0.05pF	GRM1552C2A6R9WA01#			
				±0.1pF	GRM1552C2A5R3BA01#		±0.1pF	GRM1552C2A6R9BA01#			
				±0.25pF	GRM1552C2A5R3CA01#		±0.25pF	GRM1552C2A6R9CA01#			
				±0.5pF	GRM1552C2A5R3DA01#		±0.5pF	GRM1552C2A6R9DA01#			
			5.4pF	±0.05pF	GRM1552C2A5R4WA01#	7.0pF	±0.05pF	GRM1552C2A7R0WA01#			
				±0.1pF	GRM1552C2A5R4BA01#		±0.1pF	GRM1552C2A7R0BA01#			
				±0.25pF	GRM1552C2A5R4CA01#		±0.25pF	GRM1552C2A7R0CA01#			
				±0.5pF	GRM1552C2A5R4DA01#		±0.5pF	GRM1552C2A7R0DA01#			
			5.5pF	±0.05pF	GRM1552C2A5R5WA01#						
				±0.1pF	GRM1552C2A5R5BA01#						
				±0.25pF	GRM1552C2A5R5CA01#						
				±0.5pF	GRM1552C2A5R5DA01#						
			5.6pF	±0.05pF	GRM1552C2A5R6WA01#						
				±0.1pF	GRM1552C2A5R6BA01#						
				±0.25pF	GRM1552C2A5R6CA01#						
				±0.5pF	GRM1552C2A5R6DA01#						
			5.7pF	±0.05pF	GRM1552C2A5R7WA01#						

Part number # indicates the package specification code.

GRM Series Temperature Compensating Type Part Number List

(→ 1.0×0.5mm)

T max.	Rated Voltage	TC Code	Cap.	Tol.	Part Number	T max.	Rated Voltage	TC Code	Cap.	Tol.	Part Number	
0.55mm	100Vdc	CH	7.0pF	±0.5pF	GRM1552C2A7R0DA01#	0.55mm	100Vdc	CH	8.4pF	±0.1pF	GRM1552C2A8R4BA01#	
				±0.05pF	GRM1552C2A7R1WA01#					±0.25pF	GRM1552C2A8R4CA01#	
				±0.1pF	GRM1552C2A7R1BA01#					±0.5pF	GRM1552C2A8R4DA01#	
			7.1pF	±0.25pF	GRM1552C2A7R1CA01#				8.5pF	±0.05pF	GRM1552C2A8R5WA01#	
				±0.5pF	GRM1552C2A7R1DA01#					±0.1pF	GRM1552C2A8R5BA01#	
				±0.05pF	GRM1552C2A7R2WA01#					±0.25pF	GRM1552C2A8R5CA01#	
				±0.1pF	GRM1552C2A7R2BA01#					±0.5pF	GRM1552C2A8R5DA01#	
			7.2pF	±0.25pF	GRM1552C2A7R2CA01#				8.6pF	±0.05pF	GRM1552C2A8R6WA01#	
				±0.5pF	GRM1552C2A7R2DA01#					±0.1pF	GRM1552C2A8R6BA01#	
				±0.05pF	GRM1552C2A7R3WA01#					±0.25pF	GRM1552C2A8R6CA01#	
			7.3pF	±0.1pF	GRM1552C2A7R3BA01#				8.7pF	±0.5pF	GRM1552C2A8R6DA01#	
				±0.25pF	GRM1552C2A7R3CA01#					±0.05pF	GRM1552C2A8R7WA01#	
				±0.5pF	GRM1552C2A7R3DA01#					±0.1pF	GRM1552C2A8R7BA01#	
			7.4pF	±0.05pF	GRM1552C2A7R4WA01#				8.8pF	±0.25pF	GRM1552C2A8R7CA01#	
				±0.1pF	GRM1552C2A7R4BA01#					±0.5pF	GRM1552C2A8R7DA01#	
				±0.25pF	GRM1552C2A7R4CA01#					±0.05pF	GRM1552C2A8R8WA01#	
				±0.5pF	GRM1552C2A7R4DA01#					±0.1pF	GRM1552C2A8R8BA01#	
			7.5pF	±0.25pF	GRM1552C2A7R5CA01#				8.9pF	±0.25pF	GRM1552C2A8R8CA01#	
				±0.5pF	GRM1552C2A7R5DA01#					±0.5pF	GRM1552C2A8R8DA01#	
				±0.05pF	GRM1552C2A7R5WA01#					±0.05pF	GRM1552C2A8R9WA01#	
			7.6pF	±0.1pF	GRM1552C2A7R5BA01#				9.0pF	±0.1pF	GRM1552C2A8R9BA01#	
				±0.25pF	GRM1552C2A7R5CA01#					±0.25pF	GRM1552C2A8R9CA01#	
				±0.5pF	GRM1552C2A7R5DA01#					±0.5pF	GRM1552C2A8R9DA01#	
				±0.05pF	GRM1552C2A7R6WA01#					9.1pF	±0.05pF	GRM1552C2A9R0WA01#
			±0.1pF	GRM1552C2A7R6BA01#	±0.1pF				GRM1552C2A9R0BA01#			
			±0.25pF	GRM1552C2A7R6CA01#	±0.25pF				GRM1552C2A9R0CA01#			
			7.7pF	±0.5pF	GRM1552C2A7R6DA01#				9.2pF	±0.5pF	GRM1552C2A9R0DA01#	
				±0.05pF	GRM1552C2A7R7WA01#					±0.05pF	GRM1552C2A9R1WA01#	
				±0.1pF	GRM1552C2A7R7BA01#					±0.1pF	GRM1552C2A9R1BA01#	
			7.8pF	±0.25pF	GRM1552C2A7R7CA01#				9.3pF	±0.25pF	GRM1552C2A9R1CA01#	
				±0.5pF	GRM1552C2A7R7DA01#					±0.5pF	GRM1552C2A9R1DA01#	
				±0.05pF	GRM1552C2A7R8WA01#					9.4pF	±0.05pF	GRM1552C2A9R2WA01#
				±0.1pF	GRM1552C2A7R8BA01#						±0.1pF	GRM1552C2A9R2BA01#
			±0.25pF	GRM1552C2A7R8CA01#	±0.25pF				GRM1552C2A9R2CA01#			
			7.9pF	±0.5pF	GRM1552C2A7R8DA01#				9.5pF	±0.5pF	GRM1552C2A9R2DA01#	
				±0.05pF	GRM1552C2A7R9WA01#					±0.05pF	GRM1552C2A9R3WA01#	
				±0.1pF	GRM1552C2A7R9BA01#					±0.1pF	GRM1552C2A9R3BA01#	
			8.0pF	±0.25pF	GRM1552C2A7R9CA01#				9.6pF	±0.25pF	GRM1552C2A9R3CA01#	
				±0.5pF	GRM1552C2A7R9DA01#					±0.5pF	GRM1552C2A9R3DA01#	
				±0.05pF	GRM1552C2A8R0WA01#					9.7pF	±0.05pF	GRM1552C2A9R4WA01#
				±0.1pF	GRM1552C2A8R0BA01#						±0.1pF	GRM1552C2A9R4BA01#
			±0.25pF	GRM1552C2A8R0CA01#	±0.25pF				GRM1552C2A9R4CA01#			
			8.1pF	±0.5pF	GRM1552C2A8R0DA01#				9.8pF	±0.5pF	GRM1552C2A9R4DA01#	
				±0.05pF	GRM1552C2A8R1WA01#					±0.05pF	GRM1552C2A9R5WA01#	
				±0.1pF	GRM1552C2A8R1BA01#					±0.1pF	GRM1552C2A9R5BA01#	
			8.2pF	±0.25pF	GRM1552C2A8R1CA01#				9.9pF	±0.25pF	GRM1552C2A9R5CA01#	
				±0.5pF	GRM1552C2A8R1DA01#					±0.5pF	GRM1552C2A9R5DA01#	
				±0.05pF	GRM1552C2A8R2WA01#					10.0pF	±0.05pF	GRM1552C2A9R6WA01#
				±0.1pF	GRM1552C2A8R2BA01#						±0.1pF	GRM1552C2A9R6BA01#
			±0.25pF	GRM1552C2A8R2CA01#	±0.25pF				GRM1552C2A9R6CA01#			
			8.3pF	±0.5pF	GRM1552C2A8R2DA01#				10.1pF	±0.5pF	GRM1552C2A9R6DA01#	
				±0.05pF	GRM1552C2A8R3WA01#					±0.05pF	GRM1552C2A9R7WA01#	
				±0.1pF	GRM1552C2A8R3BA01#					±0.1pF	GRM1552C2A9R7BA01#	
			8.4pF	±0.25pF	GRM1552C2A8R3CA01#				10.2pF	±0.25pF	GRM1552C2A9R7CA01#	
				±0.5pF	GRM1552C2A8R3DA01#					±0.5pF	GRM1552C2A9R7DA01#	
				±0.05pF	GRM1552C2A8R4WA01#					±0.05pF	GRM1552C2A9R8WA01#	
				±0.1pF	GRM1552C2A8R4BA01#					±0.1pF	GRM1552C2A9R8BA01#	

Part number # indicates the package specification code.

GRM Series
 GJM Series
 GMA Series
 GMD Series
 GQM Series
 GR3 Series
 GRJ Series
 LLA Series
 LLL Series
 LLM Series
 LLR Series
 KRM Series
 KR3 Series
 NFM Series
 GCH Series
 ⚠Caution/ Notice

GRM Series Temperature Compensating Type Part Number List

(→ 1.0×0.5mm)

T max.	Rated Voltage	TC Code	Cap.	Tol.	Part Number	T max.	Rated Voltage	TC Code	Cap.	Tol.	Part Number						
0.55mm	100Vdc	CH	9.7pF	±0.5pF	GRM1552C2A9R7DA01#	0.55mm	50Vdc	COG	1.0pF	±0.25pF	GRM1555C1H1R0CA01#						
			9.8pF	±0.05pF	GRM1552C2A9R8WA01#				1.1pF	±0.05pF	GRM1555C1H1R1WA01#						
				±0.1pF	GRM1552C2A9R8BA01#					±0.1pF	GRM1555C1H1R1BA01#						
				±0.25pF	GRM1552C2A9R8CA01#					±0.25pF	GRM1555C1H1R1CA01#						
				±0.5pF	GRM1552C2A9R8DA01#					1.2pF	±0.05pF	GRM1555C1H1R2WA01#					
			±0.1pF	GRM1552C2A9R9BA01#	±0.1pF				GRM1555C1H1R2BA01#								
			±0.25pF	GRM1552C2A9R9CA01#	±0.25pF				GRM1555C1H1R2CA01#								
			9.9pF	±0.05pF	GRM1552C2A9R9WA01#				1.3pF	±0.05pF	GRM1555C1H1R3WA01#						
				±0.1pF	GRM1552C2A9R9BA01#					±0.1pF	GRM1555C1H1R3BA01#						
				±0.25pF	GRM1552C2A9R9CA01#					±0.25pF	GRM1555C1H1R3CA01#						
			10pF	±2%	GRM1552C2A100GA01#				1.4pF	±0.05pF	GRM1555C1H1R4WA01#						
				±5%	GRM1552C2A100JA01#					±0.1pF	GRM1555C1H1R4BA01#						
			12pF	±2%	GRM1552C2A120GA01#				1.5pF	±0.05pF	GRM1555C1H1R5WA01#						
				±5%	GRM1552C2A120JA01#					±0.1pF	GRM1555C1H1R5BA01#						
			15pF	±2%	GRM1552C2A150GA01#				1.6pF	±0.05pF	GRM1555C1H1R6WA01#						
				±5%	GRM1552C2A150JA01#					±0.1pF	GRM1555C1H1R6BA01#						
			18pF	±2%	GRM1552C2A180GA01#				1.7pF	±0.05pF	GRM1555C1H1R7WA01#						
				±5%	GRM1552C2A180JA01#					±0.1pF	GRM1555C1H1R7BA01#						
			22pF	±2%	GRM1552C2A220GA01#				1.8pF	±0.05pF	GRM1555C1H1R8WA01#						
				±5%	GRM1552C2A220JA01#					±0.1pF	GRM1555C1H1R8BA01#						
			27pF	±2%	GRM1552C2A270GA01#				1.9pF	±0.05pF	GRM1555C1H1R9WA01#						
				±5%	GRM1552C2A270JA01#					±0.1pF	GRM1555C1H1R9BA01#						
			33pF	±2%	GRM1552C2A330GA01#				2.0pF	±0.05pF	GRM1555C1H2R0WA01#						
				±5%	GRM1552C2A330JA01#					±0.1pF	GRM1555C1H2R0BA01#						
			39pF	±2%	GRM1552C2A390GA01#				2.1pF	±0.05pF	GRM1555C1H2R1WA01#						
				±5%	GRM1552C2A390JA01#					±0.1pF	GRM1555C1H2R1BA01#						
			47pF	±2%	GRM1552C2A470GA01#				2.2pF	±0.05pF	GRM1555C1H2R2WA01#						
				±5%	GRM1552C2A470JA01#					±0.1pF	GRM1555C1H2R2BA01#						
			56pF	±2%	GRM1552C2A560GA01#				2.3pF	±0.05pF	GRM1555C1H2R3WA01#						
				±5%	GRM1552C2A560JA01#					±0.1pF	GRM1555C1H2R3BA01#						
			68pF	±2%	GRM1552C2A680GA01#				2.4pF	±0.05pF	GRM1555C1H2R4WA01#						
				±5%	GRM1552C2A680JA01#					±0.1pF	GRM1555C1H2R4BA01#						
			82pF	±2%	GRM1552C2A820GA01#				2.5pF	±0.05pF	GRM1555C1H2R5WA01#						
				±5%	GRM1552C2A820JA01#					±0.1pF	GRM1555C1H2R5BA01#						
			100pF	±2%	GRM1552C2A101GA01#				2.6pF	±0.05pF	GRM1555C1H2R6WA01#						
				±5%	GRM1552C2A101JA01#					±0.1pF	GRM1555C1H2R6BA01#						
			50Vdc	COG	COG				0.10pF	±0.05pF	GRM1555C1HR10WA01#	0.55mm	50Vdc	COG	2.7pF	±0.05pF	GRM1555C1H2R7WA01#
									0.20pF	±0.05pF	GRM1555C1HR20WA01#				2.8pF	±0.05pF	GRM1555C1H2R8WA01#
										±0.1pF	GRM1555C1HR20BA01#					±0.1pF	GRM1555C1H2R8BA01#
									0.30pF	±0.05pF	GRM1555C1HR30WA01#				2.9pF	±0.05pF	GRM1555C1H2R9WA01#
										±0.1pF	GRM1555C1HR30BA01#					±0.1pF	GRM1555C1H2R9BA01#
									0.40pF	±0.05pF	GRM1555C1HR40WA01#				3.0pF	±0.05pF	GRM1555C1H2R0WA01#
										±0.1pF	GRM1555C1HR40BA01#					±0.1pF	GRM1555C1H2R0BA01#
									0.50pF	±0.05pF	GRM1555C1HR50WA01#				3.1pF	±0.05pF	GRM1555C1H2R1WA01#
										±0.1pF	GRM1555C1HR50BA01#					±0.1pF	GRM1555C1H2R1BA01#
									0.60pF	±0.05pF	GRM1555C1HR60WA01#				3.2pF	±0.05pF	GRM1555C1H2R2WA01#
										±0.1pF	GRM1555C1HR60BA01#					±0.1pF	GRM1555C1H2R2BA01#
									0.70pF	±0.05pF	GRM1555C1HR70WA01#				3.3pF	±0.05pF	GRM1555C1H2R3WA01#
										±0.1pF	GRM1555C1HR70BA01#					±0.1pF	GRM1555C1H2R3BA01#
									0.80pF	±0.05pF	GRM1555C1HR80WA01#				3.4pF	±0.05pF	GRM1555C1H2R4WA01#
±0.1pF	GRM1555C1HR80BA01#	±0.1pF				GRM1555C1H2R4BA01#											
0.90pF	±0.05pF	GRM1555C1HR90WA01#				3.5pF	±0.05pF	GRM1555C1H2R5WA01#									
	±0.1pF	GRM1555C1HR90BA01#					±0.1pF	GRM1555C1H2R5BA01#									
1.0pF	±0.05pF	GRM1555C1H1R0WA01#				3.6pF	±0.05pF	GRM1555C1H2R6WA01#									
	±0.1pF	GRM1555C1H1R0BA01#					±0.1pF	GRM1555C1H2R6BA01#									

Part number # indicates the package specification code.

GRM Series Temperature Compensating Type Part Number List

(→ 1.0×0.5mm)

T max.	Rated Voltage	TC Code	Cap.	Tol.	Part Number	T max.	Rated Voltage	TC Code	Cap.	Tol.	Part Number		
0.55mm	50Vdc	COG	2.8pF	±0.25pF	GRM1555C1H2R8CA01#	0.55mm	50Vdc	COG	4.6pF	±0.25pF	GRM1555C1H4R6CA01#		
				2.9pF	±0.05pF					GRM1555C1H2R9WA01#	4.7pF	±0.05pF	GRM1555C1H4R7WA01#
					±0.1pF					GRM1555C1H2R9BA01#		±0.1pF	GRM1555C1H4R7BA01#
			±0.25pF		GRM1555C1H2R9CA01#				±0.25pF	GRM1555C1H4R7CA01#			
			3.0pF	±0.05pF	GRM1555C1H3R0WA01#				4.8pF	±0.05pF	GRM1555C1H4R8WA01#		
				±0.1pF	GRM1555C1H3R0BA01#					±0.1pF	GRM1555C1H4R8BA01#		
				±0.25pF	GRM1555C1H3R0CA01#					±0.25pF	GRM1555C1H4R8CA01#		
			3.1pF	±0.05pF	GRM1555C1H3R1WA01#				4.9pF	±0.05pF	GRM1555C1H4R9WA01#		
				±0.1pF	GRM1555C1H3R1BA01#					±0.1pF	GRM1555C1H4R9BA01#		
				±0.25pF	GRM1555C1H3R1CA01#					±0.25pF	GRM1555C1H4R9CA01#		
			3.2pF	±0.05pF	GRM1555C1H3R2WA01#				5.0pF	±0.05pF	GRM1555C1H5R0WA01#		
				±0.1pF	GRM1555C1H3R2BA01#					±0.1pF	GRM1555C1H5R0BA01#		
				±0.25pF	GRM1555C1H3R2CA01#					±0.25pF	GRM1555C1H5R0CA01#		
			3.3pF	±0.05pF	GRM1555C1H3R3WA01#				5.1pF	±0.05pF	GRM1555C1H5R1WA01#		
				±0.1pF	GRM1555C1H3R3BA01#					±0.1pF	GRM1555C1H5R1BA01#		
				±0.25pF	GRM1555C1H3R3CA01#					±0.25pF	GRM1555C1H5R1CA01#		
			3.4pF	±0.05pF	GRM1555C1H3R4WA01#				5.2pF	±0.05pF	GRM1555C1H5R2WA01#		
				±0.1pF	GRM1555C1H3R4BA01#					±0.1pF	GRM1555C1H5R2BA01#		
				±0.25pF	GRM1555C1H3R4CA01#					±0.25pF	GRM1555C1H5R2CA01#		
			3.5pF	±0.05pF	GRM1555C1H3R5WA01#				5.3pF	±0.05pF	GRM1555C1H5R3WA01#		
				±0.1pF	GRM1555C1H3R5BA01#					±0.1pF	GRM1555C1H5R3BA01#		
				±0.25pF	GRM1555C1H3R5CA01#					±0.25pF	GRM1555C1H5R3CA01#		
			3.6pF	±0.05pF	GRM1555C1H3R6WA01#				5.4pF	±0.05pF	GRM1555C1H5R4WA01#		
				±0.1pF	GRM1555C1H3R6BA01#					±0.1pF	GRM1555C1H5R4BA01#		
				±0.25pF	GRM1555C1H3R6CA01#					±0.25pF	GRM1555C1H5R4CA01#		
			3.7pF	±0.05pF	GRM1555C1H3R7WA01#				5.5pF	±0.05pF	GRM1555C1H5R5WA01#		
				±0.1pF	GRM1555C1H3R7BA01#					±0.1pF	GRM1555C1H5R5BA01#		
				±0.25pF	GRM1555C1H3R7CA01#					±0.25pF	GRM1555C1H5R5CA01#		
			3.8pF	±0.05pF	GRM1555C1H3R8WA01#				5.6pF	±0.05pF	GRM1555C1H5R6WA01#		
				±0.1pF	GRM1555C1H3R8BA01#					±0.1pF	GRM1555C1H5R6BA01#		
				±0.25pF	GRM1555C1H3R8CA01#					±0.25pF	GRM1555C1H5R6CA01#		
			3.9pF	±0.05pF	GRM1555C1H3R9WA01#				5.7pF	±0.05pF	GRM1555C1H5R7WA01#		
				±0.1pF	GRM1555C1H3R9BA01#					±0.1pF	GRM1555C1H5R7BA01#		
				±0.25pF	GRM1555C1H3R9CA01#					±0.25pF	GRM1555C1H5R7CA01#		
			4.0pF	±0.05pF	GRM1555C1H4R0WA01#				5.8pF	±0.05pF	GRM1555C1H5R8WA01#		
				±0.1pF	GRM1555C1H4R0BA01#					±0.1pF	GRM1555C1H5R8BA01#		
				±0.25pF	GRM1555C1H4R0CA01#					±0.25pF	GRM1555C1H5R8CA01#		
			4.1pF	±0.05pF	GRM1555C1H4R1WA01#				5.9pF	±0.05pF	GRM1555C1H5R9WA01#		
				±0.1pF	GRM1555C1H4R1BA01#					±0.1pF	GRM1555C1H5R9BA01#		
				±0.25pF	GRM1555C1H4R1CA01#					±0.25pF	GRM1555C1H5R9CA01#		
			4.2pF	±0.05pF	GRM1555C1H4R2WA01#				6.0pF	±0.05pF	GRM1555C1H6R0WA01#		
				±0.1pF	GRM1555C1H4R2BA01#					±0.1pF	GRM1555C1H6R0BA01#		
				±0.25pF	GRM1555C1H4R2CA01#					±0.25pF	GRM1555C1H6R0CA01#		
			4.3pF	±0.05pF	GRM1555C1H4R3WA01#				6.1pF	±0.05pF	GRM1555C1H6R1WA01#		
				±0.1pF	GRM1555C1H4R3BA01#								
				±0.25pF	GRM1555C1H4R3CA01#								
			4.4pF	±0.05pF	GRM1555C1H4R4WA01#								
				±0.1pF	GRM1555C1H4R4BA01#								
±0.25pF	GRM1555C1H4R4CA01#												
4.5pF	±0.05pF	GRM1555C1H4R5WA01#											
	±0.1pF	GRM1555C1H4R5BA01#											
	±0.25pF	GRM1555C1H4R5CA01#											
4.6pF	±0.05pF	GRM1555C1H4R6WA01#											
	±0.1pF	GRM1555C1H4R6BA01#											

Part number # indicates the package specification code.

GRM Series
 GJM Series
 GMA Series
 GMD Series
 GQM Series
 GR3 Series
 GRJ Series
 LLA Series
 LLL Series
 LLM Series
 LLR Series
 KRM Series
 KR3 Series
 NFM Series
 GCH Series
 ⚠Caution/ Notice

GRM Series Temperature Compensating Type Part Number List

(→ 1.0×0.5mm)

T max.	Rated Voltage	TC Code	Cap.	Tol.	Part Number	T max.	Rated Voltage	TC Code	Cap.	Tol.	Part Number	
0.55mm	50Vdc	COG	6.1pF	±0.1pF	GRM1555C1H6R1BA01#	0.55mm	50Vdc	COG	7.4pF	±0.5pF	GRM1555C1H7R4DA01#	
				±0.25pF	GRM1555C1H6R1CA01#					7.5pF	±0.05pF	GRM1555C1H7R5WA01#
				±0.5pF	GRM1555C1H6R1DA01#						±0.1pF	GRM1555C1H7R5BA01#
			6.2pF	±0.05pF	GRM1555C1H6R2WA01#				±0.25pF		GRM1555C1H7R5CA01#	
				±0.1pF	GRM1555C1H6R2BA01#				±0.5pF	GRM1555C1H7R5DA01#		
				±0.25pF	GRM1555C1H6R2CA01#				7.6pF	±0.05pF	GRM1555C1H7R6WA01#	
			±0.5pF	GRM1555C1H6R2DA01#	±0.1pF					GRM1555C1H7R6BA01#		
			6.3pF	±0.05pF	GRM1555C1H6R3WA01#					±0.25pF	GRM1555C1H7R6CA01#	
				±0.1pF	GRM1555C1H6R3BA01#				±0.5pF	GRM1555C1H7R6DA01#		
				±0.25pF	GRM1555C1H6R3CA01#				7.7pF	±0.05pF	GRM1555C1H7R7WA01#	
			±0.5pF	GRM1555C1H6R3DA01#	±0.1pF					GRM1555C1H7R7BA01#		
			6.4pF	±0.05pF	GRM1555C1H6R4WA01#					±0.25pF	GRM1555C1H7R7CA01#	
				±0.1pF	GRM1555C1H6R4BA01#				±0.5pF	GRM1555C1H7R7DA01#		
				±0.25pF	GRM1555C1H6R4CA01#				7.8pF	±0.05pF	GRM1555C1H7R8WA01#	
			±0.5pF	GRM1555C1H6R4DA01#	±0.1pF					GRM1555C1H7R8BA01#		
			6.5pF	±0.05pF	GRM1555C1H6R5WA01#					±0.25pF	GRM1555C1H7R8CA01#	
				±0.1pF	GRM1555C1H6R5BA01#				±0.5pF	GRM1555C1H7R8DA01#		
				±0.25pF	GRM1555C1H6R5CA01#				7.9pF	±0.05pF	GRM1555C1H7R9WA01#	
			±0.5pF	GRM1555C1H6R5DA01#	±0.1pF					GRM1555C1H7R9BA01#		
			6.6pF	±0.05pF	GRM1555C1H6R6WA01#					±0.25pF	GRM1555C1H7R9CA01#	
				±0.1pF	GRM1555C1H6R6BA01#				±0.5pF	GRM1555C1H7R9DA01#		
				±0.25pF	GRM1555C1H6R6CA01#				8.0pF	±0.05pF	GRM1555C1H8R0WA01#	
			±0.5pF	GRM1555C1H6R6DA01#	±0.1pF					GRM1555C1H8R0BA01#		
			6.7pF	±0.05pF	GRM1555C1H6R7WA01#					±0.25pF	GRM1555C1H8R0CA01#	
				±0.1pF	GRM1555C1H6R7BA01#				±0.5pF	GRM1555C1H8R0DA01#		
				±0.25pF	GRM1555C1H6R7CA01#				8.1pF	±0.05pF	GRM1555C1H8R1WA01#	
			±0.5pF	GRM1555C1H6R7DA01#	±0.1pF					GRM1555C1H8R1BA01#		
			6.8pF	±0.05pF	GRM1555C1H6R8WA01#					±0.25pF	GRM1555C1H8R1CA01#	
				±0.1pF	GRM1555C1H6R8BA01#				±0.5pF	GRM1555C1H8R1DA01#		
				±0.25pF	GRM1555C1H6R8CA01#				8.2pF	±0.05pF	GRM1555C1H8R2WA01#	
			±0.5pF	GRM1555C1H6R8DA01#	±0.1pF					GRM1555C1H8R2BA01#		
			6.9pF	±0.05pF	GRM1555C1H6R9WA01#					±0.25pF	GRM1555C1H8R2CA01#	
				±0.1pF	GRM1555C1H6R9BA01#				±0.5pF	GRM1555C1H8R2DA01#		
				±0.25pF	GRM1555C1H6R9CA01#				8.3pF	±0.05pF	GRM1555C1H8R3WA01#	
			±0.5pF	GRM1555C1H6R9DA01#	±0.1pF					GRM1555C1H8R3BA01#		
			7.0pF	±0.05pF	GRM1555C1H7R0WA01#					±0.25pF	GRM1555C1H8R3CA01#	
				±0.1pF	GRM1555C1H7R0BA01#				±0.5pF	GRM1555C1H8R3DA01#		
				±0.25pF	GRM1555C1H7R0CA01#				8.4pF	±0.05pF	GRM1555C1H8R4WA01#	
			±0.5pF	GRM1555C1H7R0DA01#	±0.1pF					GRM1555C1H8R4BA01#		
			7.1pF	±0.05pF	GRM1555C1H7R1WA01#					±0.25pF	GRM1555C1H8R4CA01#	
				±0.1pF	GRM1555C1H7R1BA01#				±0.5pF	GRM1555C1H8R4DA01#		
				±0.25pF	GRM1555C1H7R1CA01#				8.5pF	±0.05pF	GRM1555C1H8R5WA01#	
			±0.5pF	GRM1555C1H7R1DA01#	±0.1pF					GRM1555C1H8R5BA01#		
			7.2pF	±0.05pF	GRM1555C1H7R2WA01#					±0.25pF	GRM1555C1H8R5CA01#	
				±0.1pF	GRM1555C1H7R2BA01#				±0.5pF	GRM1555C1H8R5DA01#		
				±0.25pF	GRM1555C1H7R2CA01#				8.6pF	±0.05pF	GRM1555C1H8R6WA01#	
			±0.5pF	GRM1555C1H7R2DA01#	±0.1pF					GRM1555C1H8R6BA01#		
			7.3pF	±0.05pF	GRM1555C1H7R3WA01#					±0.25pF	GRM1555C1H8R6CA01#	
				±0.1pF	GRM1555C1H7R3BA01#				±0.5pF	GRM1555C1H8R6DA01#		
				±0.25pF	GRM1555C1H7R3CA01#				8.7pF	±0.05pF	GRM1555C1H8R7WA01#	
			±0.5pF	GRM1555C1H7R3DA01#	±0.1pF					GRM1555C1H8R7BA01#		
			7.4pF	±0.05pF	GRM1555C1H7R4WA01#					±0.25pF	GRM1555C1H8R7CA01#	
				±0.1pF	GRM1555C1H7R4BA01#				±0.5pF	GRM1555C1H8R7DA01#		
				±0.25pF	GRM1555C1H7R4CA01#				8.8pF	±0.05pF	GRM1555C1H8R8WA01#	

Part number # indicates the package specification code.

GRM Series
 GJM Series
 GMA Series
 GMD Series
 GQM Series
 GR3 Series
 GRJ Series
 LLA Series
 LLL Series
 LLM Series
 LLP Series
 KRM Series
 KR3 Series
 NFM Series
 GCH Series
 ⚠Caution/
 Notice

GRM Series Temperature Compensating Type Part Number List

(→ 1.0×0.5mm)

T max.	Rated Voltage	TC Code	Cap.	Tol.	Part Number	T max.	Rated Voltage	TC Code	Cap.	Tol.	Part Number	
0.55mm	50Vdc	COG	8.8pF	±0.1pF	GRM1555C1H8R8BA01#	0.55mm	50Vdc	COG	18pF	±5%	GRM1555C1H180JA01#	
				±0.25pF	GRM1555C1H8R8CA01#					22pF	±2%	GRM1555C1H220GA01#
				±0.5pF	GRM1555C1H8R8DA01#						±5%	GRM1555C1H220JA01#
			8.9pF	±0.05pF	GRM1555C1H8R9WA01#				27pF	±2%	GRM1555C1H270GA01#	
				±0.1pF	GRM1555C1H8R9BA01#					±5%	GRM1555C1H270JA01#	
				±0.25pF	GRM1555C1H8R9CA01#				33pF	±2%	GRM1555C1H330GA01#	
			±0.5pF	GRM1555C1H8R9DA01#	±5%					GRM1555C1H330JA01#		
			9.0pF	±0.05pF	GRM1555C1H9R0WA01#				39pF	±2%	GRM1555C1H390GA01#	
				±0.1pF	GRM1555C1H9R0BA01#					±5%	GRM1555C1H390JA01#	
				±0.25pF	GRM1555C1H9R0CA01#				47pF	±2%	GRM1555C1H470GA01#	
				±0.5pF	GRM1555C1H9R0DA01#					±5%	GRM1555C1H470JA01#	
			9.1pF	±0.05pF	GRM1555C1H9R1WA01#				56pF	±2%	GRM1555C1H560GA01#	
				±0.1pF	GRM1555C1H9R1BA01#					±5%	GRM1555C1H560JA01#	
				±0.25pF	GRM1555C1H9R1CA01#				68pF	±2%	GRM1555C1H680GA01#	
				±0.5pF	GRM1555C1H9R1DA01#					±5%	GRM1555C1H680JA01#	
			9.2pF	±0.05pF	GRM1555C1H9R2WA01#				82pF	±2%	GRM1555C1H820GA01#	
				±0.1pF	GRM1555C1H9R2BA01#					±5%	GRM1555C1H820JA01#	
				±0.25pF	GRM1555C1H9R2CA01#				100pF	±2%	GRM1555C1H101GA01#	
				±0.5pF	GRM1555C1H9R2DA01#					±5%	GRM1555C1H101JA01#	
			9.3pF	±0.05pF	GRM1555C1H9R3WA01#				120pF	±2%	GRM1555C1H121GA01#	
				±0.1pF	GRM1555C1H9R3BA01#					±5%	GRM1555C1H121JA01#	
				±0.25pF	GRM1555C1H9R3CA01#				150pF	±2%	GRM1555C1H151GA01#	
				±0.5pF	GRM1555C1H9R3DA01#					±5%	GRM1555C1H151JA01#	
			9.4pF	±0.05pF	GRM1555C1H9R4WA01#				180pF	±2%	GRM1555C1H181GA01#	
				±0.1pF	GRM1555C1H9R4BA01#					±5%	GRM1555C1H181JA01#	
				±0.25pF	GRM1555C1H9R4CA01#				220pF	±2%	GRM1555C1H221GA01#	
				±0.5pF	GRM1555C1H9R4DA01#					±5%	GRM1555C1H221JA01#	
			9.5pF	±0.05pF	GRM1555C1H9R5WA01#				270pF	±2%	GRM1555C1H271GA01#	
				±0.1pF	GRM1555C1H9R5BA01#					±5%	GRM1555C1H271JA01#	
				±0.25pF	GRM1555C1H9R5CA01#				330pF	±2%	GRM1555C1H331GA01#	
				±0.5pF	GRM1555C1H9R5DA01#					±5%	GRM1555C1H331JA01#	
			9.6pF	±0.05pF	GRM1555C1H9R6WA01#				390pF	±2%	GRM1555C1H391GA01#	
				±0.1pF	GRM1555C1H9R6BA01#					±5%	GRM1555C1H391JA01#	
				±0.25pF	GRM1555C1H9R6CA01#				470pF	±2%	GRM1555C1H471GA01#	
				±0.5pF	GRM1555C1H9R6DA01#					±5%	GRM1555C1H471JA01#	
			9.7pF	±0.05pF	GRM1555C1H9R7WA01#				560pF	±2%	GRM1555C1H561GA01#	
				±0.1pF	GRM1555C1H9R7BA01#					±5%	GRM1555C1H561JA01#	
				±0.25pF	GRM1555C1H9R7CA01#				680pF	±2%	GRM1555C1H681GA01#	
				±0.5pF	GRM1555C1H9R7DA01#					±5%	GRM1555C1H681JA01#	
			9.8pF	±0.05pF	GRM1555C1H9R8WA01#				820pF	±2%	GRM1555C1H821GA01#	
				±0.1pF	GRM1555C1H9R8BA01#					±5%	GRM1555C1H821JA01#	
				±0.25pF	GRM1555C1H9R8CA01#				1000pF	±2%	GRM1555C1H102GA01#	
				±0.5pF	GRM1555C1H9R8DA01#					±5%	GRM1555C1H102JA01#	
			9.9pF	±0.05pF	GRM1555C1H9R9WA01#				CK	±0.05pF	GRM1554C1HR10WA01#	
				±0.1pF	GRM1555C1H9R9BA01#					±0.05pF	GRM1554C1HR20WA01#	
				±0.25pF	GRM1555C1H9R9CA01#					±0.1pF	GRM1554C1HR20BA01#	
				±0.5pF	GRM1555C1H9R9DA01#					±0.05pF	GRM1554C1HR30WA01#	
			10pF	±2%	GRM1555C1H100GA01#				±0.1pF	GRM1554C1HR30BA01#		
				±5%	GRM1555C1H100JA01#				0.40pF	±0.05pF	GRM1554C1HR40WA01#	
			12pF	±2%	GRM1555C1H120GA01#					±0.1pF	GRM1554C1HR40BA01#	
				±5%	GRM1555C1H120JA01#				0.50pF	±0.05pF	GRM1554C1HR50WA01#	
			15pF	±2%	GRM1555C1H150GA01#					±0.1pF	GRM1554C1HR50BA01#	
				±5%	GRM1555C1H150JA01#				0.60pF	±0.05pF	GRM1554C1HR60WA01#	
			18pF	±2%	GRM1555C1H180GA01#					±0.1pF	GRM1554C1HR60BA01#	

Part number # indicates the package specification code.

GRM Series
 GJM Series
 GVA Series
 GMD Series
 GQM Series
 GR3 Series
 GRJ Series
 LLA Series
 LLL Series
 LLM Series
 LLR Series
 KRM Series
 KR3 Series
 NFM Series
 GCH Series
 ⚠Caution/ Notice

GRM Series Temperature Compensating Type Part Number List

(→ 1.0×0.5mm)

T max.	Rated Voltage	TC Code	Cap.	Tol.	Part Number	T max.	Rated Voltage	TC Code	Cap.	Tol.	Part Number
0.55mm	50Vdc	CK	0.70pF	±0.05pF	GRM1554C1HR70WA01#	0.55mm	50Vdc	CJ	2.6pF	±0.05pF	GRM1553C1H2R6WA01#
				±0.1pF	GRM1554C1HR70BA01#					±0.05pF	GRM1553C1H2R6BA01#
			±0.25pF	GRM1554C1HR70CA01#	±0.1pF					GRM1553C1H2R6CA01#	
			0.80pF	±0.05pF	GRM1554C1HR80WA01#					±0.25pF	GRM1553C1H2R6CA01#
				±0.1pF	GRM1554C1HR80BA01#					2.7pF	±0.05pF
			±0.25pF	GRM1554C1HR80CA01#	±0.1pF						GRM1553C1H2R7BA01#
			0.90pF	±0.05pF	GRM1554C1HR90WA01#				±0.25pF	GRM1553C1H2R7CA01#	
				±0.1pF	GRM1554C1HR90BA01#				2.8pF	±0.05pF	GRM1553C1H2R8WA01#
			±0.25pF	GRM1554C1HR90CA01#	±0.1pF					GRM1553C1H2R8BA01#	
			1.0pF	±0.05pF	GRM1554C1H1R0WA01#					±0.25pF	GRM1553C1H2R8CA01#
				±0.1pF	GRM1554C1H1R0BA01#				2.9pF	±0.05pF	GRM1553C1H2R9WA01#
				±0.25pF	GRM1554C1H1R0CA01#					±0.1pF	GRM1553C1H2R9BA01#
			1.1pF	±0.05pF	GRM1554C1H1R1WA01#					±0.25pF	GRM1553C1H2R9CA01#
				±0.1pF	GRM1554C1H1R1BA01#				3.0pF	±0.05pF	GRM1553C1H3R0WA01#
				±0.25pF	GRM1554C1H1R1CA01#					±0.1pF	GRM1553C1H3R0BA01#
			1.2pF	±0.05pF	GRM1554C1H1R2WA01#					±0.25pF	GRM1553C1H3R0CA01#
				±0.1pF	GRM1554C1H1R2BA01#				3.1pF	±0.05pF	GRM1553C1H3R1WA01#
				±0.25pF	GRM1554C1H1R2CA01#					±0.1pF	GRM1553C1H3R1BA01#
			1.3pF	±0.05pF	GRM1554C1H1R3WA01#					±0.25pF	GRM1553C1H3R1CA01#
				±0.1pF	GRM1554C1H1R3BA01#				3.2pF	±0.05pF	GRM1553C1H3R2WA01#
				±0.25pF	GRM1554C1H1R3CA01#					±0.1pF	GRM1553C1H3R2BA01#
			1.4pF	±0.05pF	GRM1554C1H1R4WA01#					±0.25pF	GRM1553C1H3R2CA01#
				±0.1pF	GRM1554C1H1R4BA01#				3.3pF	±0.05pF	GRM1553C1H3R3WA01#
				±0.25pF	GRM1554C1H1R4CA01#					±0.1pF	GRM1553C1H3R3BA01#
		1.5pF	±0.05pF	GRM1554C1H1R5WA01#	±0.25pF	GRM1553C1H3R3CA01#					
			±0.1pF	GRM1554C1H1R5BA01#	3.4pF	±0.05pF	GRM1553C1H3R4WA01#				
			±0.25pF	GRM1554C1H1R5CA01#		±0.1pF	GRM1553C1H3R4BA01#				
		1.6pF	±0.05pF	GRM1554C1H1R6WA01#		±0.25pF	GRM1553C1H3R4CA01#				
			±0.1pF	GRM1554C1H1R6BA01#	3.5pF	±0.05pF	GRM1553C1H3R5WA01#				
			±0.25pF	GRM1554C1H1R6CA01#		±0.1pF	GRM1553C1H3R5BA01#				
		1.7pF	±0.05pF	GRM1554C1H1R7WA01#		±0.25pF	GRM1553C1H3R5CA01#				
			±0.1pF	GRM1554C1H1R7BA01#	3.6pF	±0.05pF	GRM1553C1H3R6WA01#				
			±0.25pF	GRM1554C1H1R7CA01#		±0.1pF	GRM1553C1H3R6BA01#				
		1.8pF	±0.05pF	GRM1554C1H1R8WA01#		±0.25pF	GRM1553C1H3R6CA01#				
			±0.1pF	GRM1554C1H1R8BA01#	3.7pF	±0.05pF	GRM1553C1H3R7WA01#				
			±0.25pF	GRM1554C1H1R8CA01#		±0.1pF	GRM1553C1H3R7BA01#				
		1.9pF	±0.05pF	GRM1554C1H1R9WA01#		±0.25pF	GRM1553C1H3R7CA01#				
			±0.1pF	GRM1554C1H1R9BA01#	3.8pF	±0.05pF	GRM1553C1H3R8WA01#				
			±0.25pF	GRM1554C1H1R9CA01#		±0.1pF	GRM1553C1H3R8BA01#				
		2.0pF	±0.05pF	GRM1554C1H2R0WA01#		±0.25pF	GRM1553C1H3R8CA01#				
			±0.1pF	GRM1554C1H2R0BA01#	3.9pF	±0.05pF	GRM1553C1H3R9WA01#				
			±0.25pF	GRM1554C1H2R0CA01#		±0.1pF	GRM1553C1H3R9BA01#				
		2.1pF	±0.05pF	GRM1553C1H2R1WA01#		±0.25pF	GRM1553C1H3R9CA01#				
			±0.1pF	GRM1553C1H2R1BA01#	CH	4.0pF	±0.05pF	GRM1552C1H4R0WA01#			
			±0.25pF	GRM1553C1H2R1CA01#			±0.1pF	GRM1552C1H4R0BA01#			
		2.2pF	±0.05pF	GRM1553C1H2R2WA01#			±0.25pF	GRM1552C1H4R0CA01#			
			±0.1pF	GRM1553C1H2R2BA01#	4.1pF	±0.05pF	GRM1552C1H4R1WA01#				
			±0.25pF	GRM1553C1H2R2CA01#		±0.1pF	GRM1552C1H4R1BA01#				
2.3pF	±0.05pF	GRM1553C1H2R3WA01#	±0.25pF	GRM1552C1H4R1CA01#							
	±0.1pF	GRM1553C1H2R3BA01#	4.2pF	±0.05pF	GRM1552C1H4R2WA01#						
	±0.25pF	GRM1553C1H2R3CA01#		±0.1pF	GRM1552C1H4R2BA01#						
2.4pF	±0.05pF	GRM1553C1H2R4WA01#		±0.25pF	GRM1552C1H4R2CA01#						
	±0.1pF	GRM1553C1H2R4BA01#	4.3pF	±0.05pF	GRM1552C1H4R3WA01#						
	±0.25pF	GRM1553C1H2R4CA01#		±0.1pF	GRM1552C1H4R3BA01#						
2.5pF	±0.05pF	GRM1553C1H2R5WA01#		±0.25pF	GRM1552C1H4R3CA01#						
	±0.1pF	GRM1553C1H2R5BA01#									
	±0.25pF	GRM1553C1H2R5CA01#									

Part number # indicates the package specification code.

GRM Series Temperature Compensating Type Part Number List

(→ 1.0×0.5mm)

T max.	Rated Voltage	TC Code	Cap.	Tol.	Part Number
0.55mm	50Vdc	CH	4.4pF	±0.05pF	GRM1552C1H4R4WA01#
				±0.1pF	GRM1552C1H4R4BA01#
				±0.25pF	GRM1552C1H4R4CA01#
			4.5pF	±0.05pF	GRM1552C1H4R5WA01#
				±0.1pF	GRM1552C1H4R5BA01#
				±0.25pF	GRM1552C1H4R5CA01#
			4.6pF	±0.05pF	GRM1552C1H4R6WA01#
				±0.1pF	GRM1552C1H4R6BA01#
				±0.25pF	GRM1552C1H4R6CA01#
			4.7pF	±0.05pF	GRM1552C1H4R7WA01#
				±0.1pF	GRM1552C1H4R7BA01#
				±0.25pF	GRM1552C1H4R7CA01#
			4.8pF	±0.05pF	GRM1552C1H4R8WA01#
				±0.1pF	GRM1552C1H4R8BA01#
				±0.25pF	GRM1552C1H4R8CA01#
			4.9pF	±0.05pF	GRM1552C1H4R9WA01#
				±0.1pF	GRM1552C1H4R9BA01#
				±0.25pF	GRM1552C1H4R9CA01#
			5.0pF	±0.05pF	GRM1552C1H5R0WA01#
				±0.1pF	GRM1552C1H5R0BA01#
				±0.25pF	GRM1552C1H5R0CA01#
			5.1pF	±0.05pF	GRM1552C1H5R1WA01#
				±0.1pF	GRM1552C1H5R1BA01#
				±0.25pF	GRM1552C1H5R1CA01#
				±0.5pF	GRM1552C1H5R1DA01#
			5.2pF	±0.05pF	GRM1552C1H5R2WA01#
				±0.1pF	GRM1552C1H5R2BA01#
				±0.25pF	GRM1552C1H5R2CA01#
				±0.5pF	GRM1552C1H5R2DA01#
			5.3pF	±0.05pF	GRM1552C1H5R3WA01#
				±0.1pF	GRM1552C1H5R3BA01#
				±0.25pF	GRM1552C1H5R3CA01#
				±0.5pF	GRM1552C1H5R3DA01#
			5.4pF	±0.05pF	GRM1552C1H5R4WA01#
				±0.1pF	GRM1552C1H5R4BA01#
				±0.25pF	GRM1552C1H5R4CA01#
				±0.5pF	GRM1552C1H5R4DA01#
			5.5pF	±0.05pF	GRM1552C1H5R5WA01#
				±0.1pF	GRM1552C1H5R5BA01#
				±0.25pF	GRM1552C1H5R5CA01#
				±0.5pF	GRM1552C1H5R5DA01#
			5.6pF	±0.05pF	GRM1552C1H5R6WA01#
				±0.1pF	GRM1552C1H5R6BA01#
				±0.25pF	GRM1552C1H5R6CA01#
				±0.5pF	GRM1552C1H5R6DA01#
			5.7pF	±0.05pF	GRM1552C1H5R7WA01#
				±0.1pF	GRM1552C1H5R7BA01#
				±0.25pF	GRM1552C1H5R7CA01#
				±0.5pF	GRM1552C1H5R7DA01#
			5.8pF	±0.05pF	GRM1552C1H5R8WA01#
				±0.1pF	GRM1552C1H5R8BA01#
				±0.25pF	GRM1552C1H5R8CA01#
				±0.5pF	GRM1552C1H5R8DA01#
			5.9pF	±0.05pF	GRM1552C1H5R9WA01#

T max.	Rated Voltage	TC Code	Cap.	Tol.	Part Number
0.55mm	50Vdc	CH	5.9pF	±0.1pF	GRM1552C1H5R9BA01#
				±0.25pF	GRM1552C1H5R9CA01#
				±0.5pF	GRM1552C1H5R9DA01#
			6.0pF	±0.05pF	GRM1552C1H6R0WA01#
				±0.1pF	GRM1552C1H6R0BA01#
				±0.25pF	GRM1552C1H6R0CA01#
				±0.5pF	GRM1552C1H6R0DA01#
			6.1pF	±0.05pF	GRM1552C1H6R1WA01#
				±0.1pF	GRM1552C1H6R1BA01#
				±0.25pF	GRM1552C1H6R1CA01#
			6.2pF	±0.05pF	GRM1552C1H6R2WA01#
				±0.1pF	GRM1552C1H6R2BA01#
				±0.25pF	GRM1552C1H6R2CA01#
			6.3pF	±0.05pF	GRM1552C1H6R3WA01#
				±0.1pF	GRM1552C1H6R3BA01#
				±0.25pF	GRM1552C1H6R3CA01#
			6.4pF	±0.05pF	GRM1552C1H6R4WA01#
				±0.1pF	GRM1552C1H6R4BA01#
				±0.25pF	GRM1552C1H6R4CA01#
			6.5pF	±0.05pF	GRM1552C1H6R5WA01#
				±0.1pF	GRM1552C1H6R5BA01#
				±0.25pF	GRM1552C1H6R5CA01#
				±0.5pF	GRM1552C1H6R5DA01#
			6.6pF	±0.05pF	GRM1552C1H6R6WA01#
				±0.1pF	GRM1552C1H6R6BA01#
				±0.25pF	GRM1552C1H6R6CA01#
				±0.5pF	GRM1552C1H6R6DA01#
			6.7pF	±0.05pF	GRM1552C1H6R7WA01#
				±0.1pF	GRM1552C1H6R7BA01#
				±0.25pF	GRM1552C1H6R7CA01#
				±0.5pF	GRM1552C1H6R7DA01#
			6.8pF	±0.05pF	GRM1552C1H6R8WA01#
				±0.1pF	GRM1552C1H6R8BA01#
				±0.25pF	GRM1552C1H6R8CA01#
				±0.5pF	GRM1552C1H6R8DA01#
			6.9pF	±0.05pF	GRM1552C1H6R9WA01#
				±0.1pF	GRM1552C1H6R9BA01#
				±0.25pF	GRM1552C1H6R9CA01#
				±0.5pF	GRM1552C1H6R9DA01#
			7.0pF	±0.05pF	GRM1552C1H7R0WA01#
				±0.1pF	GRM1552C1H7R0BA01#
				±0.25pF	GRM1552C1H7R0CA01#
			7.1pF	±0.05pF	GRM1552C1H7R1WA01#
				±0.1pF	GRM1552C1H7R1BA01#
				±0.25pF	GRM1552C1H7R1CA01#
				±0.5pF	GRM1552C1H7R1DA01#
			7.2pF	±0.05pF	GRM1552C1H7R2WA01#
				±0.1pF	GRM1552C1H7R2BA01#
				±0.25pF	GRM1552C1H7R2CA01#

Part number # indicates the package specification code.

GRM Series
 GJM Series
 GVA Series
 GMD Series
 GQM Series
 GR3 Series
 GRJ Series
 LLA Series
 LLL Series
 LLL Series
 LLL Series
 LLR Series
 KRM Series
 KR3 Series
 NFM Series
 GCH Series
 ⚠Caution/ Notice

GRM Series Temperature Compensating Type Part Number List

(→ 1.0×0.5mm)

T max.	Rated Voltage	TC Code	Cap.	Tol.	Part Number	
0.55mm	50Vdc	CH	7.2pF	±0.5pF	GRM1552C1H7R2DA01#	
				7.3pF	±0.05pF	GRM1552C1H7R3WA01#
					±0.1pF	GRM1552C1H7R3BA01#
			±0.25pF		GRM1552C1H7R3CA01#	
			±0.5pF		GRM1552C1H7R3DA01#	
			7.4pF	±0.05pF	GRM1552C1H7R4WA01#	
				±0.1pF	GRM1552C1H7R4BA01#	
				±0.25pF	GRM1552C1H7R4CA01#	
			7.5pF	±0.05pF	GRM1552C1H7R5WA01#	
				±0.1pF	GRM1552C1H7R5BA01#	
				±0.25pF	GRM1552C1H7R5CA01#	
			7.6pF	±0.05pF	GRM1552C1H7R6WA01#	
				±0.1pF	GRM1552C1H7R6BA01#	
				±0.25pF	GRM1552C1H7R6CA01#	
			7.7pF	±0.05pF	GRM1552C1H7R7WA01#	
				±0.1pF	GRM1552C1H7R7BA01#	
				±0.25pF	GRM1552C1H7R7CA01#	
			7.8pF	±0.05pF	GRM1552C1H7R8WA01#	
				±0.1pF	GRM1552C1H7R8BA01#	
				±0.25pF	GRM1552C1H7R8CA01#	
			7.9pF	±0.05pF	GRM1552C1H7R9WA01#	
				±0.1pF	GRM1552C1H7R9BA01#	
				±0.25pF	GRM1552C1H7R9CA01#	
			8.0pF	±0.05pF	GRM1552C1H8R0WA01#	
				±0.1pF	GRM1552C1H8R0BA01#	
				±0.25pF	GRM1552C1H8R0CA01#	
			8.1pF	±0.05pF	GRM1552C1H8R1WA01#	
				±0.1pF	GRM1552C1H8R1BA01#	
				±0.25pF	GRM1552C1H8R1CA01#	
			8.2pF	±0.05pF	GRM1552C1H8R2WA01#	
				±0.1pF	GRM1552C1H8R2BA01#	
				±0.25pF	GRM1552C1H8R2CA01#	
			8.3pF	±0.05pF	GRM1552C1H8R3WA01#	
				±0.1pF	GRM1552C1H8R3BA01#	
				±0.25pF	GRM1552C1H8R3CA01#	
			8.4pF	±0.05pF	GRM1552C1H8R4WA01#	
				±0.1pF	GRM1552C1H8R4BA01#	
				±0.25pF	GRM1552C1H8R4CA01#	
			8.5pF	±0.05pF	GRM1552C1H8R5WA01#	
				±0.1pF	GRM1552C1H8R5BA01#	
				±0.25pF	GRM1552C1H8R5CA01#	
			8.6pF	±0.05pF	GRM1552C1H8R6WA01#	

T max.	Rated Voltage	TC Code	Cap.	Tol.	Part Number
0.55mm	50Vdc	CH	8.6pF	±0.1pF	GRM1552C1H8R6BA01#
				±0.25pF	GRM1552C1H8R6CA01#
				±0.5pF	GRM1552C1H8R6DA01#
			8.7pF	±0.05pF	GRM1552C1H8R7WA01#
				±0.1pF	GRM1552C1H8R7BA01#
				±0.25pF	GRM1552C1H8R7CA01#
			8.8pF	±0.05pF	GRM1552C1H8R8WA01#
				±0.1pF	GRM1552C1H8R8BA01#
				±0.25pF	GRM1552C1H8R8CA01#
			8.9pF	±0.05pF	GRM1552C1H8R9WA01#
				±0.1pF	GRM1552C1H8R9BA01#
				±0.25pF	GRM1552C1H8R9CA01#
			9.0pF	±0.05pF	GRM1552C1H9R0WA01#
				±0.1pF	GRM1552C1H9R0BA01#
				±0.25pF	GRM1552C1H9R0CA01#
			9.1pF	±0.05pF	GRM1552C1H9R1WA01#
				±0.1pF	GRM1552C1H9R1BA01#
				±0.25pF	GRM1552C1H9R1CA01#
			9.2pF	±0.05pF	GRM1552C1H9R2WA01#
				±0.1pF	GRM1552C1H9R2BA01#
				±0.25pF	GRM1552C1H9R2CA01#
			9.3pF	±0.05pF	GRM1552C1H9R3WA01#
				±0.1pF	GRM1552C1H9R3BA01#
				±0.25pF	GRM1552C1H9R3CA01#
			9.4pF	±0.05pF	GRM1552C1H9R4WA01#
				±0.1pF	GRM1552C1H9R4BA01#
				±0.25pF	GRM1552C1H9R4CA01#
			9.5pF	±0.05pF	GRM1552C1H9R5WA01#
				±0.1pF	GRM1552C1H9R5BA01#
				±0.25pF	GRM1552C1H9R5CA01#
			9.6pF	±0.05pF	GRM1552C1H9R6WA01#
				±0.1pF	GRM1552C1H9R6BA01#
				±0.25pF	GRM1552C1H9R6CA01#
			9.7pF	±0.05pF	GRM1552C1H9R7WA01#
				±0.1pF	GRM1552C1H9R7BA01#
				±0.25pF	GRM1552C1H9R7CA01#
			9.8pF	±0.05pF	GRM1552C1H9R8WA01#
				±0.1pF	GRM1552C1H9R8BA01#
				±0.25pF	GRM1552C1H9R8CA01#
			9.9pF	±0.05pF	GRM1552C1H9R9WA01#
				±0.1pF	GRM1552C1H9R9BA01#
				±0.25pF	GRM1552C1H9R9CA01#

Part number # indicates the package specification code.

GRM Series Temperature Compensating Type Part Number List

(→ 1.0×0.5mm)

T max.	Rated Voltage	TC Code	Cap.	Tol.	Part Number
0.55mm	50Vdc	CH	9.9pF	±0.5pF	GRM1552C1H9R9DA01#
				±2%	GRM1552C1H100GA01#
			10pF	±5%	GRM1552C1H100JA01#
				±2%	GRM1552C1H120GA01#
			12pF	±5%	GRM1552C1H120JA01#
				±2%	GRM1552C1H150GA01#
			15pF	±5%	GRM1552C1H150JA01#
				±2%	GRM1552C1H180GA01#
			18pF	±5%	GRM1552C1H180JA01#
				±2%	GRM1552C1H220GA01#
			22pF	±5%	GRM1552C1H220JA01#
				±2%	GRM1552C1H270GA01#
			27pF	±5%	GRM1552C1H270JA01#
				±2%	GRM1552C1H330GA01#
			33pF	±5%	GRM1552C1H330JA01#
				±2%	GRM1552C1H390GA01#
			39pF	±5%	GRM1552C1H390JA01#
				±2%	GRM1552C1H470GA01#
			47pF	±5%	GRM1552C1H470JA01#
				±2%	GRM1552C1H560GA01#
			56pF	±5%	GRM1552C1H560JA01#
				±2%	GRM1552C1H680GA01#
			68pF	±5%	GRM1552C1H680JA01#
				±2%	GRM1552C1H820GA01#
			82pF	±5%	GRM1552C1H820JA01#
				±2%	GRM1552C1H101GA01#
			100pF	±5%	GRM1552C1H101JA01#
				±2%	GRM1552C1H121GA01#
			120pF	±5%	GRM1552C1H121JA01#
				±2%	GRM1552C1H151GA01#
			150pF	±5%	GRM1552C1H151JA01#
				±2%	GRM1552C1H181GA01#
			180pF	±5%	GRM1552C1H181JA01#
				±2%	GRM1552C1H221GA01#
			220pF	±5%	GRM1552C1H221JA01#
				±2%	GRM1552C1H271GA01#
			270pF	±5%	GRM1552C1H271JA01#
				±2%	GRM1552C1H331GA01#
			330pF	±5%	GRM1552C1H331JA01#
				±2%	GRM1552C1H391GA01#
			390pF	±5%	GRM1552C1H391JA01#
				±2%	GRM1552C1H471GA01#
			470pF	±5%	GRM1552C1H471JA01#
				±2%	GRM1552C1H561GA01#
			560pF	±5%	GRM1552C1H561JA01#
				±2%	GRM1552C1H681GA01#
			680pF	±5%	GRM1552C1H681JA01#
				±2%	GRM1552C1H821GA01#
820pF	±5%	GRM1552C1H821JA01#			
	±2%	GRM1552C1H102GA01#			
1000pF	±5%	GRM1552C1H102JA01#			
	±2%	GRM1551X1A122JA01#			
10Vdc	SL	1500pF	±5%	GRM1551X1A152JA01#	
		1800pF	±5%	GRM1551X1A182JA01#	

T max.	Rated Voltage	TC Code	Cap.	Tol.	Part Number		
0.55mm	10Vdc	SL	2200pF	±5%	GRM1551X1A222JA01#		
				±5%	GRM1551X1A272JA01#		
				±5%	GRM1551X1A332JA01#		
			3900pF	±5%	GRM1551X1A392JA01#		
				4700pF	±5%	GRM1551X1A472JA01#	
					U2J	1200pF	±5%
			1500pF			±5%	GRM1557U1A152JA01#
			1800pF	±5%		GRM1557U1A182JA01#	
			2200pF	±5%	GRM1557U1A222JA01#		
				3300pF	±5%	GRM1557U1A332JA01#	
					3900pF	±5%	GRM1557U1A392JA01#
			4700pF			±5%	GRM1557U1A472JA01#
		UJ		1200pF		±5%	GRM1553U1A122JA01#
					±5%	GRM1553U1A152JA01#	
			±5%		GRM1553U1A182JA01#		
			2200pF	±5%	GRM1553U1A222JA01#		
				2700pF	±5%	GRM1553U1A272JA01#	
					3300pF	±5%	GRM1553U1A332JA01#
			3900pF			±5%	GRM1553U1A392JA01#
				4700pF		±5%	GRM1553U1A472JA01#

1.6×0.8mm

T max.	Rated Voltage	TC Code	Cap.	Tol.	Part Number		
0.5mm	50Vdc	SL	2200pF	±5%	GRM1851X1H222JA44#		
				±5%	GRM1851X1H272JA44#		
				±5%	GRM1851X1H332JA44#		
			3900pF	±5%	GRM1851X1H392JA44#		
				4700pF	±5%	GRM1851X1H472JA44#	
					U2J	2200pF	±5%
			2700pF			±5%	GRM1857U1H272JA44#
			3300pF	±5%		GRM1857U1H332JA44#	
			3900pF	±5%	GRM1857U1H392JA44#		
				4700pF	±5%	GRM1857U1H472JA44#	
					UJ	2200pF	±5%
			2700pF			±5%	GRM1853U1H272JA44#
		3300pF	±5%	GRM1853U1H332JA44#			
		3900pF	±5%	GRM1853U1H392JA44#			
			4700pF	±5%	GRM1853U1H472JA44#		
				10Vdc	SL	5600pF	±5%
		6800pF				±5%	GRM1851X1A682JA44#
		8200pF	±5%			GRM1851X1A822JA44#	
		10000pF	±5%	GRM1851X1A103JA44#			
			U2J	5600pF	±5%	GRM1857U1A562JA44#	
				6800pF	±5%	GRM1857U1A682JA44#	
		8200pF		±5%	GRM1857U1A822JA44#		
		10000pF	±5%	GRM1857U1A103JA44#			
			UJ	5600pF	±5%	GRM1853U1A562JA44#	
	6800pF			±5%	GRM1853U1A682JA44#		
	8200pF	±5%		GRM1853U1A822JA44#			
	10000pF	±5%	GRM1853U1A103JA44#				
		0.9mm	100Vdc	COG	0.50pF	±0.05pF	GRM1885C2AR50WA01#

Part number # indicates the package specification code.

GRM Series
 GJM Series
 GVA Series
 GMD Series
 GQM Series
 GR3 Series
 GRJ Series
 LLA Series
 LLL Series
 LLM Series
 LLR Series
 KRM Series
 KR3 Series
 NFM Series
 GCH Series
 ⚠Caution/Notice

GRM Series High Dielectric Constant Type Part Number List

(→ 0.6×0.3mm)

T max.	Rated Voltage	TC Code	Cap.	Tol.	Part Number		
0.33mm	16Vdc	X5R	4700pF	±10%	GRM033R61C473KE84#	D1	
				±20%	GRM033R61C473ME84#	D1	
			6800pF	±10%	GRM033R61C683KE84#	D1	
				±20%	GRM033R61C683ME84#	D1	
			0.10μF	±10%	GRM033R61C104KE14#		
				±20%	GRM033R61C104ME14#		
			B	2200pF	±10%	GRM033B31C222KA87#	
					±20%	GRM033B31C222MA87#	
				3300pF	±10%	GRM033B31C332KA87#	
					±20%	GRM033B31C332MA87#	
				10000pF	±10%	GRM033B31C103KA12#	
					±20%	GRM033B31C103MA12#	
		15000pF		±10%	GRM033B31C153KE84#	D1	
				±20%	GRM033B31C153ME84#	D1	
		22000pF		±10%	GRM033B31C223KE84#	D1	
				±20%	GRM033B31C223ME84#	D1	
		33000pF		±10%	GRM033B31C333KE84#	D1	
				±20%	GRM033B31C333ME84#	D1	
		47000pF	±10%	GRM033B31C473KE84#	D1		
			±20%	GRM033B31C473ME84#	D1		
		68000pF	±10%	GRM033B31C683KE84#	D1		
			±20%	GRM033B31C683ME84#	D1		
		0.10μF	±10%	GRM033B31C104KE84#	D1		
			±20%	GRM033B31C104ME84#	D1		
	10Vdc	X7R	4700pF	±10%	GRM033R71A472KA01#		
				±20%	GRM033R71A472MA01#		
			6800pF	±10%	GRM033R71A682KA01#		
				±20%	GRM033R71A682MA01#		
			10000pF	±10%	GRM033R71A103KA01#		
				±20%	GRM033R71A103MA01#		
			X7S	0.10μF	±10%	GRM033C71A104KE14#	
					±20%	GRM033C71A104ME14#	
			R	4700pF	±10%	GRM033R11A472KA01#	
					±20%	GRM033R11A472MA01#	
				6800pF	±10%	GRM033R11A682KA01#	
					±20%	GRM033R11A682MA01#	
		10000pF	±10%	GRM033R11A103KA01#			
			±20%	GRM033R11A103MA01#			
		X5R	4700pF	±10%	GRM033R61A472KA01#		
				±20%	GRM033R61A472MA01#		
			6800pF	±10%	GRM033R61A682KA01#		
				±20%	GRM033R61A682MA01#		
			15000pF	±10%	GRM033R61A153KE84#		
				±20%	GRM033R61A153ME84#		
			22000pF	±10%	GRM033R61A223KE84#		
				±20%	GRM033R61A223ME84#		
			33000pF	±10%	GRM033R61A333KE84#		
				±20%	GRM033R61A333ME84#		
47000pF	±10%		GRM033R61A473KE84#				
	±20%		GRM033R61A473ME84#				
68000pF	±10%	GRM033R61A683KE84#					
	±20%	GRM033R61A683ME84#					
0.10μF	±10%	GRM033R61A104KE84#					
	±20%	GRM033R61A104ME84#					

T max.	Rated Voltage	TC Code	Cap.	Tol.	Part Number		
0.33mm	10Vdc	X5R	0.22μF	±20%	GRM033R61A224ME90#	D1	
			B	4700pF	±10%	GRM033B11A472KA01#	
					±20%	GRM033B11A472MA01#	
			6800pF	±10%	GRM033B11A682KA01#		
				±20%	GRM033B11A682MA01#		
			15000pF	±10%	GRM033B31A153KE84#		
				±20%	GRM033B31A153ME84#		
			22000pF	±10%	GRM033B31A223KE84#		
				±20%	GRM033B31A223ME84#		
			33000pF	±10%	GRM033B31A333KE84#		
				±20%	GRM033B31A333ME84#		
		47000pF	±10%	GRM033B31A473KE84#			
			±20%	GRM033B31A473ME84#			
		68000pF	±10%	GRM033B31A683KE84#			
			±20%	GRM033B31A683ME84#			
		0.10μF	±10%	GRM033B31A104KE84#			
			±20%	GRM033B31A104ME84#			
		6.3Vdc	X7R	4700pF	±10%	GRM033R70J472KA01#	
					±20%	GRM033R70J472MA01#	
				6800pF	±10%	GRM033R70J682KA01#	
					±20%	GRM033R70J682MA01#	
				10000pF	±10%	GRM033R70J103KA01#	
					±20%	GRM033R70J103MA01#	
	R		4700pF	±10%	GRM033R10J472KA01#		
				±20%	GRM033R10J472MA01#		
			6800pF	±10%	GRM033R10J682KA01#		
				±20%	GRM033R10J682MA01#		
			10000pF	±10%	GRM033R10J103KA01#		
				±20%	GRM033R10J103MA01#		
	X6S	15000pF	±10%	GRM033C80J153KE01#			
			±20%	GRM033C80J153ME01#			
		22000pF	±10%	GRM033C80J223KE01#			
			±20%	GRM033C80J223ME01#			
		33000pF	±10%	GRM033C80J333KE01#			
			±20%	GRM033C80J333ME01#			
	47000pF	±10%	GRM033C80J473KE19#				
		±20%	GRM033C80J473ME19#				
	68000pF	±10%	GRM033C80J683KE84#	D1			
		±20%	GRM033C80J683ME84#	D1			
		0.10μF	±10%	GRM033C80J104KE84#	D1		
			±20%	GRM033C80J104ME84#	D1		
	0.22μF	±20%	GRM033C80J224ME90#	D1			
	4Vdc	X5R	0.22μF	±20%	GRM033R60J224ME90#		
			B	4700pF	±10%	GRM033B10J472KA01#	
					±20%	GRM033B10J472MA01#	
6800pF			±10%	GRM033B10J682KA01#			
			±20%	GRM033B10J682MA01#			
15000pF		±10%	GRM033B10J153KE01#				
		±20%	GRM033B10J153ME01#				
22000pF		±10%	GRM033B10J223KE01#				
		±20%	GRM033B10J223ME01#				
33000pF		±10%	GRM033B10J333KE01#				
		±20%	GRM033B10J333ME01#				
47000pF	±10%	GRM033C80G224ME90#					
	±20%	GRM033C80G224ME90#					

1.0×0.5mm

T max.	Rated Voltage	TC Code	Cap.	Tol.	Part Number	
0.22mm	10Vdc	X5R	0.10μF	±10%	GRM152R61A104KE19#	D1
				±20%	GRM152R61A104ME19#	D1
			0.22μF	±10%	GRM152R61A224KE19#	D1

Part number # indicates the package specification code.

GRM Series High Dielectric Constant Type Part Number List

(→ 1.0×0.5mm)

T max.	Rated Voltage	TC Code	Cap.	Tol.	Part Number			
0.22mm	10Vdc	X5R	0.22μF	±20%	GRM152R61A224ME19#	D1		
				±10%	GRM152B31A104KE19#	D1		
			±20%	GRM152B31A104ME19#	D1			
			0.10μF	±10%	GRM152B31A224KE19#	D1		
				±20%	GRM152B31A224ME19#	D1		
			6.3Vdc	X6S	0.10μF	±10%	GRM152C80J104KE19#	D1
		±20%				GRM152C80J104ME19#	D1	
		0.22μF			±10%	GRM152C80J224KE19#	D1	
					±20%	GRM152C80J224ME19#	D1	
		X5R			0.10μF	±10%	GRM152R60J104KE19#	
						±20%	GRM152R60J104ME19#	
			0.22μF	±10%	GRM152R60J224KE19#			
	±20%			GRM152R60J224ME19#				
	0.47μF		±20%	GRM152R60J474ME15#	D1			
			±20%	GRM152R60J105ME15#	D1			
	B	0.10μF	±10%	GRM152B30J104KE19#				
			±20%	GRM152B30J104ME19#				
		0.22μF	±10%	GRM152B30J224KE19#				
			±20%	GRM152B30J224ME19#				
		0.47μF	±20%	GRM152B30J474ME15#	D1			
	4Vdc	X7T	0.10μF	±10%	GRM152D70G104KE15#	D1		
				±20%	GRM152D70G104ME15#	D1		
			0.22μF	±10%	GRM152D70G224KE15#	D1		
				±20%	GRM152D70G224ME15#	D1		
			X6S	0.10μF	±10%	GRM152C80G104KE19#		
					±20%	GRM152C80G104ME19#		
		0.22μF		±10%	GRM152C80G224KE19#			
				±20%	GRM152C80G224ME19#			
		X6T		0.47μF	±20%	GRM152D80G474ME15#		
				1.0μF	±20%	GRM152D80G105ME15#	D1	
		X5R	1.0μF	±20%	GRM152R60G105ME15#			
		2.5Vdc	X7T	0.10μF	±10%	GRM152D70E104KE19#		
					±20%	GRM152D70E104ME19#		
				0.22μF	±10%	GRM152D70E224KE19#		
±20%					GRM152D70E224ME19#			
0.3mm	50Vdc	X7R	220pF	±10%	GRM15XR71H221KA86#			
			330pF	±10%	GRM15XR71H331KA86#			
			470pF	±10%	GRM15XR71H471KA86#			
			680pF	±10%	GRM15XR71H681KA86#			
			1000pF	±10%	GRM15XR71H102KA86#			
			1500pF	±10%	GRM15XR71H152KA86#			
			R	220pF	±10%	GRM15XR11H221KA86#		
				330pF	±10%	GRM15XR11H331KA86#		
				470pF	±10%	GRM15XR11H471KA86#		
				680pF	±10%	GRM15XR11H681KA86#		
				1000pF	±10%	GRM15XR11H102KA86#		
				1500pF	±10%	GRM15XR11H152KA86#		
			B	220pF	±10%	GRM15XB11H221KA86#		
					±20%	GRM15XB11H221MA86#		
				330pF	±10%	GRM15XB11H331KA86#		
					±20%	GRM15XB11H331MA86#		
				470pF	±10%	GRM15XB11H471KA86#		
					±20%	GRM15XB11H471MA86#		
		680pF	±10%	GRM15XB11H681KA86#				

T max.	Rated Voltage	TC Code	Cap.	Tol.	Part Number			
0.3mm	50Vdc	B	680pF	±20%	GRM15XB11H681MA86#			
				±10%	GRM15XB11H102KA86#			
			±20%	GRM15XB11H102MA86#				
			1000pF	±10%	GRM15XB11H152KA86#			
				±20%	GRM15XB11H152MA86#			
			25Vdc	X7R	2200pF	±10%	GRM15XR71E222KA86#	
		±20%				GRM15XR71E222MA86#		
		B		2200pF	±10%	GRM15XB11E222KA86#		
					±20%	GRM15XB11E222MA86#		
		16Vdc		X7R	3300pF	±10%	GRM15XR71C332KA86#	
						±20%	GRM15XR71C332MA86#	
			4700pF		±10%	GRM15XR71C472KA86#		
					±20%	GRM15XR71C472MA86#		
			6800pF		±10%	GRM15XR71C682KA86#		
					±20%	GRM15XR71C682MA86#		
			B	10000pF	±10%	GRM15XR71C103KA86#		
					±20%	GRM15XR71C103MA86#		
				3300pF	±10%	GRM15XB11C332KA86#		
	±20%				GRM15XB11C332MA86#			
	4700pF			±10%	GRM15XB11C472KA86#			
				±20%	GRM15XB11C472MA86#			
	10Vdc	X5R	15000pF	±10%	GRM15XR61A153KA86#			
				±20%	GRM15XR61A153MA86#			
			22000pF	±10%	GRM15XR61A223KA86#			
				±20%	GRM15XR61A223MA86#			
			33000pF	±10%	GRM15XR61A333KA86#			
				±20%	GRM15XR61A333MA86#			
	0.33mm	10Vdc	X5R	1.0μF	±20%	GRM153R61A105ME95#	D1	
			B	1.0μF	±20%	GRM153B31A105ME95#	D1	
		6.3Vdc	X6T	1.0μF	±20%	GRM153D80J105ME95#	D1	
			X5R	1.0μF	±20%	GRM153R60J105ME95#		
		4Vdc	X6T	1.0μF	±20%	GRM153B30J105ME95#		
				1.0μF	±20%	GRM153D80G105ME95#		
	0.55mm	100Vdc	X7R	220pF	±10%	GRM155R72A221KA01#		
				330pF	±10%	GRM155R72A331KA01#		
				470pF	±10%	GRM155R72A471KA01#		
680pF				±10%	GRM155R72A681KA01#			
1000pF				±10%	GRM155R72A102KA01#			
1500pF				±10%	GRM155R72A152KA01#			
2200pF				±10%	GRM155R72A222KA01#			
3300pF				±10%	GRM155R72A332KA01#			
4700pF				±10%	GRM155R72A472KA01#			
50Vdc				X7R	220pF	±10%	GRM155R71H221KA01#	
						±10%	GRM155R71H331KA01#	
					470pF	±10%	GRM155R71H471KA01#	
		±10%	GRM155R71H681KA01#					
		1000pF	±10%		GRM155R71H102KA01#			
			±10%		GRM155R71H152KA01#			
		2200pF	±10%		GRM155R71H222KA01#			
			±10%		GRM155R71H332KA01#			

Part number # indicates the package specification code.

GRM Series
GJM Series
GVA Series
GMD Series
GQM Series
GR3 Series
GRJ Series
LLA Series
LLL Series
LLM Series
LLR Series
KRM Series
KR3 Series
NFM Series
GCH Series
⚠Caution/Notice

GRM Series High Dielectric Constant Type Part Number List

(→ 1.0×0.5mm)

T max.	Rated Voltage	TC Code	Cap.	Tol.	Part Number	T max.	Rated Voltage	TC Code	Cap.	Tol.	Part Number				
0.55mm	50Vdc	X7R	4700pF	±10%	GRM155R71H472KA01#	0.55mm	50Vdc	B	4700pF	±10%	GRM155B11H472KA01#				
			6800pF	±10%	GRM155R71H682KA88#				±20%	GRM155B11H472MA01#					
			10000pF	±10%	GRM155R71H103KA88#				6800pF	±10%	GRM155B31H682KA88#				
			15000pF	±10%	GRM155R71H153KA12#				±20%	GRM155B31H682MA88#					
			22000pF	±10%	GRM155R71H223KA12#				10000pF	±10%	GRM155B31H103KA88#				
			33000pF	±10%	GRM155R71H333KE14#				±20%	GRM155B31H103MA88#					
			±20%	GRM155R71H333ME14#	15000pF				±10%	GRM155B31H153KA12#					
			47000pF	±10%	GRM155R71H473KE14#				±20%	GRM155B31H153MA12#					
			±20%	GRM155R71H473ME14#	22000pF				±10%	GRM155B31H223KA12#					
			±20%	GRM155R71H473ME14#	±20%				GRM155B31H223MA12#						
			68000pF	±10%	GRM155R71H683KE14#				0.10μF	±10%	GRM155B31H104KE14#				
			±20%	GRM155R71H683ME14#	±20%				GRM155B31H104ME14#						
			0.10μF	±10%	GRM155R71H104KE14#				±20%	GRM155B31H104ME14#					
			±20%	GRM155R71H104ME14#	35Vdc				0.22μF	±10%	GRM155C8YA224KE01#	D1			
			±20%	GRM155C8YA224ME01#						D1					
			R	220pF					±10%	GRM155R11H221KA01#	X5R	0.22μF	±10%	GRM155R6YA224KE01#	D1
				330pF					±10%	GRM155R11H331KA01#		±20%	GRM155R6YA224ME01#	D1	
			470pF	±10%					GRM155R11H471KA01#	0.47μF	±10%	GRM155R6YA474KE01#	D1		
			680pF	±10%					GRM155R11H681KA01#	±20%	GRM155R6YA474ME01#	D1			
			1000pF	±10%					GRM155R11H102KA01#	25Vdc	X7R	2200pF	±10%	GRM155R71E222KA01#	
			1500pF	±10%					GRM155R11H152KA01#			10000pF	±10%	GRM155R71E103KA01#	
			2200pF	±10%					GRM155R11H222KA01#			15000pF	±10%	GRM155R71E153KA61#	
			3300pF	±10%					GRM155R11H332KA01#			22000pF	±10%	GRM155R71E223KA61#	
			4700pF	±10%	GRM155R11H472KA01#				33000pF			±10%	GRM155R71E333KA88#		
			6800pF	±10%	GRM155R11H682KA88#				47000pF			±10%	GRM155R71E473KA88#		
			10000pF	±10%	GRM155R11H103KA88#				68000pF			±10%	GRM155R71E683KE14#		
			X6S	33000pF	±10%				GRM155C81H333KE14#			±20%	GRM155R71E683ME14#		
				±20%	GRM155C81H333ME14#				0.10μF			±10%	GRM155R71E104KE14#		
				47000pF	±10%				GRM155C81H473KE14#			±20%	GRM155R71E104ME14#		
				±20%	GRM155C81H473ME14#				R	6800pF	±10%	GRM155R11E682KA01#			
				68000pF	±10%					GRM155C81H683KE14#	10000pF	±10%	GRM155R11E103KA01#		
				±20%	GRM155C81H683ME14#					15000pF	±10%	GRM155R11E153KA61#			
			X5R	33000pF	±10%					GRM155R61H333KE14#	±20%	GRM155R61H333ME14#	22000pF	±10%	GRM155R11E223KA61#
				47000pF	±10%					GRM155R61H473KE14#	±20%	GRM155R61H473ME14#	33000pF	±10%	GRM155R11E333KA88#
				68000pF	±10%					GRM155R61H683KE14#	±20%	GRM155R61H683ME14#	47000pF	±10%	GRM155R11E473KA88#
				0.10μF	±10%				GRM155R61H104KE14#	±20%	GRM155R61H104ME14#	X6S	0.22μF	±10%	GRM155C81E224KE01#
				±20%	GRM155R61H104ME14#				±20%	GRM155C81E224ME01#					
				B	220pF				±10%	GRM155B11H221KA01#	±20%	GRM155B11H221MA01#	X5R	68000pF	±10%
			330pF		±10%				GRM155B11H331KA01#	±20%	GRM155B11H331MA01#	±20%		GRM155R61E683MA87#	
			470pF		±10%				GRM155B11H471KA01#	±20%	GRM155B11H471MA01#	0.10μF	±10%	GRM155R61E104KA87#	
			680pF		±10%				GRM155B11H681KA01#	±20%	GRM155B11H681MA01#	±20%	GRM155R61E104MA87#		
			1000pF		±10%				GRM155B11H102KA01#	±20%	GRM155B11H102MA01#	0.22μF	±10%	GRM155R61E224KE01#	
			±20%		GRM155B11H102MA01#				±20%	GRM155R61E224ME01#					
			1500pF		±10%				GRM155B11H152KA01#	±20%	GRM155B11H152MA01#	0.47μF	±10%	GRM155R61E474KE01#	
			±20%		GRM155B11H152MA01#				±20%	GRM155R61E474ME01#					
			2200pF		±10%				GRM155B11H222KA01#	±20%	GRM155B11H222MA01#	1.0μF	±10%	GRM155R61E105KA12#	
			±20%		GRM155B11H222MA01#				±20%	GRM155R61E105MA12#	D1				
			3300pF		±10%				GRM155B11H332KA01#	±20%	GRM155B11H332MA01#	B	2200pF	±10%	GRM155B11E222KA01#
			±20%		GRM155B11H332MA01#				10000pF	±10%	GRM155B11E103KA01#				
			15000pF	±10%	GRM155B11E153KA61#				±20%	GRM155B11E103MA01#					
			22000pF	±10%	GRM155B11E223KA61#				±20%	GRM155B11E153MA61#					
			±20%	GRM155B11E223MA61#	22000pF				±10%	GRM155B11E223KA61#					
			±20%	GRM155B11E223MA61#	33000pF				±10%	GRM155B31E333KA87#					

Part number # indicates the package specification code.

GRM Series High Dielectric Constant Type Part Number List

(→ 1.0×0.5mm)

T max.	Rated Voltage	TC Code	Cap.	Tol.	Part Number	
0.55mm	25Vdc	B	3300pF	±20%	GRM155B31E333MA87#	
			4700pF	±10%	GRM155B31E473KA87#	
				±20%	GRM155B31E473MA87#	
				±10%	GRM155B31E683KA87#	
			6800pF	±10%	GRM155B31E683MA87#	
				±20%	GRM155B31E104KA87#	
			0.10µF	±10%	GRM155B31E104MA87#	
				±20%	GRM155B31E105KA12#	
	1.0µF	±10%	GRM155B31E105MA12#			
		±20%	GRM155B31E105MA12#			
	16Vdc	X7R	4700pF	±10%	GRM155R71C472KA01#	
				±10%	GRM155R71C103KA01#	
				±20%	GRM155R71C103MA01#	
			6800pF	±10%	GRM155R71C683KA88#	
				±10%	GRM155R71C154KA12#	
			0.22µF	±10%	GRM155R71C224KA12#	
		R	6800pF	±10%	GRM155R11C683KA88#	
			X6S	0.47µF	±10%	GRM155C81C474KE01#
		±20%		GRM155C81C474ME01#		
		X5R	0.22µF	±10%	GRM155R61C224KA12#	
				±20%	GRM155R61C224MA12#	
			0.47µF	±10%	GRM155R61C474KE01#	
				±20%	GRM155R61C474ME01#	
		1.0µF	±10%	GRM155R61C105KA12#		
			±20%	GRM155R61C105MA12#		
			B	1000pF	±10%	GRM155B11C103KA01#
				±20%	GRM155B11C103MA01#	
		1.0µF	±10%	GRM155B31C105KA12#		
±20%			GRM155B31C105MA12#			
10Vdc		X7R	0.22µF	±10%	GRM155R71A224KE01#	
	±20%			GRM155R71A224ME01#		
	±10%			GRM155R71A474KE01#		
	0.47µF		±10%	GRM155R71A474ME01#		
			±20%	GRM155R71A474ME01#		
			±10%	GRM155C81A105KA12#		
	X6S	1.0µF	±10%	GRM155C81A105MA12#		
		±20%	GRM155C81A105MA12#			
	X5R	3300pF	±10%	GRM155R61A333KA01#		
			±10%	GRM155R61A104KA01#		
		0.10µF	±10%	GRM155R61A104MA01#		
			±20%	GRM155R61A154KE19#		
		0.15µF	±10%	GRM155R61A154ME19#		
			±20%	GRM155R61A224KE19#		
		0.22µF	±10%	GRM155R61A224ME19#		
			±20%	GRM155R61A334KE15#		
		0.33µF	±10%	GRM155R61A334ME15#		
			±20%	GRM155R61A474KE15#		
		0.47µF	±10%	GRM155R61A474ME15#		
			±20%	GRM155R61A684KE15#		
	0.68µF	±10%	GRM155R61A684ME15#			
		±20%	GRM155R61A105ME01#			
	B	0.15µF	±10%	GRM155B31A154KE18#		
			±20%	GRM155B31A154ME18#		
		0.22µF	±10%	GRM155B31A224KE18#		
			±20%	GRM155B31A224ME18#		
		0.33µF	±10%	GRM155B31A334KE14#		
			±20%	GRM155B31A334ME14#		

T max.	Rated Voltage	TC Code	Cap.	Tol.	Part Number	
0.55mm	10Vdc	B	0.47µF	±10%	GRM155B31A474KE14#	
				±20%	GRM155B31A474ME14#	
			0.68µF	±10%	GRM155B31A684KE15#	
				±20%	GRM155B31A684ME15#	
			1.0µF	±20%	GRM155B31A105ME01#	
				±10%	GRM155B31A225KE95#	
		2.2µF	±10%	GRM155B31A225ME95#		
			±20%	GRM155B31A225ME95#		
		6.3Vdc	X7R	1.0µF	±10%	GRM155R70J105KA12#
					±20%	GRM155R70J105MA12#
			X6S	0.22µF	±10%	GRM155C80J224KE01#
					±20%	GRM155C80J224ME01#
	2.2µF			±10%	GRM155C80J225KE95#	
				±20%	GRM155C80J225ME95#	
	X5R	0.10µF	±10%	GRM155R60J104KA01#		
			±20%	GRM155R60J104MA01#		
		0.15µF	±10%	GRM155R60J154KE01#		
			±20%	GRM155R60J154ME01#		
		0.22µF	±10%	GRM155R60J224KE01#		
			±20%	GRM155R60J224ME01#		
		0.33µF	±10%	GRM155R60J334KE01#		
			±20%	GRM155R60J334ME01#		
		0.47µF	±10%	GRM155R60J474KE19#		
			±20%	GRM155R60J474ME19#		
		0.68µF	±10%	GRM155R60J684KE19#		
			±20%	GRM155R60J684ME19#		
	1.0µF	±20%	GRM155R60J105ME19#			
		B	0.15µF	±10%	GRM155B10J154KE01#	
±20%	GRM155B10J154ME01#					
±10%	GRM155B10J224KE01#					
0.22µF	±10%	GRM155B10J224ME01#				
	±20%	GRM155B10J224ME01#				
	±10%	GRM155B10J334KE01#				
0.33µF	±10%	GRM155B10J334ME01#				
	±20%	GRM155B10J334ME01#				
	±10%	GRM155B30J474KE18#				
0.47µF	±10%	GRM155B30J474ME18#				
	±20%	GRM155B30J474ME18#				
	±10%	GRM155B30J684KE18#				
0.68µF	±10%	GRM155B30J684ME18#				
	±20%	GRM155B30J684ME18#				
	±10%	GRM155B30J105ME18#				
2.2µF	±10%	GRM155B30J225KE95#				
	±20%	GRM155B30J225ME95#				
	±10%	GRM155R70G105KA12#				
4Vdc	X7R	1.0µF	±10%	GRM155R70G105MA12#		
			±20%	GRM155R70G105MA12#		
	X6S	0.22µF	±10%	GRM155C80G224KE01#		
±20%	GRM155C80G224ME01#					
X5R	1.0µF	±20%	GRM155R60G105ME01#			
		±10%	GRM155R6VA105KE11#			
		±20%	GRM155R6VA105ME11#			
25Vdc	X6S	1.0µF	±10%	GRM155C81E105KE11#		
			±20%	GRM155C81E105ME11#		
			±10%	GRM155C81C105KE11#		
16Vdc	X6S	1.0µF	±10%	GRM155C81C105ME11#		
			±20%	GRM155C81C105ME11#		
			±10%	GRM155R60J475ME47#		
6.3Vdc	X5R	4.7µF	±20%	GRM155B30J475ME47#		
			±10%	GRM155B30J475ME47#		
	B	4.7µF	±20%	GRM155B30G475ME47#		
4Vdc	X5R	4.7µF	±20%	GRM155R60G475ME47#		
			±10%	GRM155R60G475ME47#		
			±20%	GRM155B30G475ME47#		

Part number # indicates the package specification code.

GRM Series
GJM Series
GVA Series
GMD Series
GQM Series
GR3 Series
GRJ Series
LLA Series
LLL Series
LLM Series
LLR Series
KRM Series
KR3 Series
NFM Series
GCH Series
Caution/Notice



Storage and Operation Conditions

1. The performance of chip monolithic ceramic capacitors may be affected by the storage conditions.

1-1. Store the capacitors in the following conditions:

Room Temperature of +5°C to +40°C and a Relative Humidity of 20% to 70%.

(1) Sunlight, dust, rapid temperature changes, corrosive gas atmosphere, or high temperature and humidity conditions during storage may affect solderability and packaging performance.

Therefore, please maintain the storage temperature and humidity. Use the product within six months, as prolonged storage may cause oxidation of the terminations (outer electrodes).

(2) Please confirm solderability before using after six months. Store the capacitors without opening the original bag. Even if the storage period is short, do not exceed the specified atmospheric conditions.

1-2. Corrosive gas can react with the termination (external) electrodes or lead wires of capacitors, and result in poor solderability. Do not store the capacitors in an atmosphere consisting of corrosive gas (e.g., hydrogen sulfide, sulfur dioxide, chlorine, ammonia gas, etc.).

1-3. Due to moisture condensation caused by rapid humidity changes, or the photochemical change caused by direct sunlight on the terminal electrodes and/or the resin/epoxy coatings, the solderability and electrical performance may deteriorate. Do not store capacitors under direct sunlight or in high humidity conditions.

Rating

1. Temperature Dependent Characteristics

1. The electrical characteristics of a capacitor can change with temperature.

1-1. For capacitors having larger temperature dependency, the capacitance may change with temperature changes.

The following actions are recommended in order to ensure suitable capacitance values.

(1) Select a suitable capacitance for the operating temperature range.

(2) The capacitance may change within the rated temperature.

When you use a high dielectric constant type capacitor in a circuit that needs a tight (narrow) capacitance tolerance (e.g., a time-constant circuit), please carefully consider the temperature characteristics, and carefully confirm the various characteristics in actual use conditions and the actual system.

[Example of Temperature Characteristics X7R (R7)]

Sample: 0.1μF, Rated Voltage 50VDC

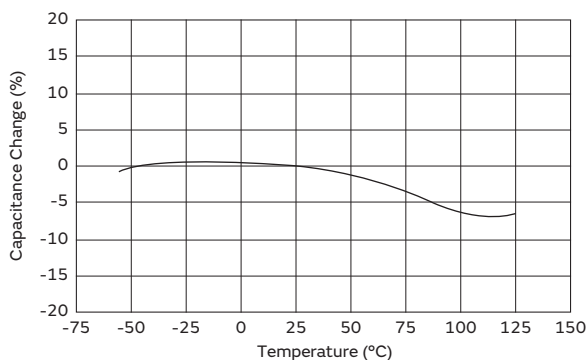

[Example of Temperature Characteristics X5R (R6)]

Sample: 22μF, Rated Voltage 4VDC

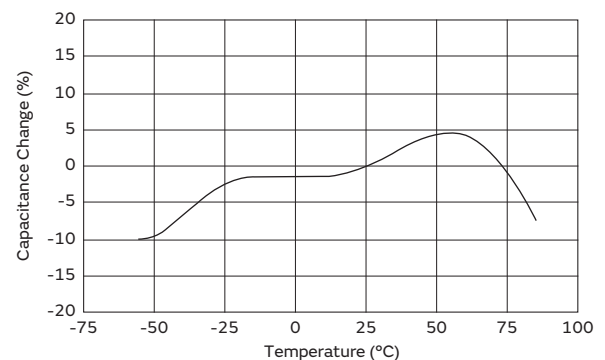

2. Measurement of Capacitance

1. Measure capacitance with the voltage and frequency specified in the product specifications.

1-1. The output voltage of the measuring equipment may decrease occasionally when capacitance is high. Please confirm whether a prescribed measured voltage is impressed to the capacitor.

1-2. The capacitance values of high dielectric constant type capacitors change depending on the AC voltage applied. Please consider the AC voltage characteristics when selecting a capacitor to be used in an AC circuit.

GRM Series
 GJM Series
 GMA Series
 GMD Series
 GQM Series
 GR3 Series
 GRJ Series
 LLA Series
 LLL Series
 LLM Series
 LLR Series
 KRM Series
 KR3 Series
 NFM Series
 GCH Series
 △CAUTION

△Caution

Continued from the preceding page. ↘

3. Applied Voltage

1. Do not apply a voltage to the capacitor that exceeds the rated voltage as called out in the specifications.
 - 1-1. Applied voltage between the terminals of a capacitor shall be less than or equal to the rated voltage.
 - (1) When AC voltage is superimposed on DC voltage, the zero-to-peak voltage shall not exceed the rated DC voltage.
 When AC voltage or pulse voltage is applied, the peak-to-peak voltage shall not exceed the rated DC voltage.
 - (2) Abnormal voltages (surge voltage, static electricity, pulse voltage, etc.) shall not exceed the rated DC voltage.

Typical Voltage Applied to the DC Capacitor

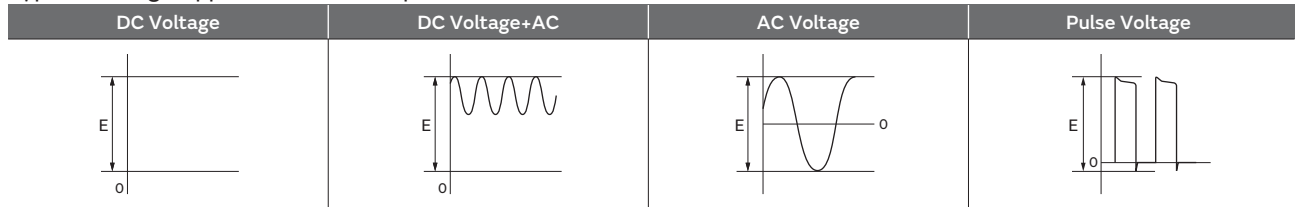

(E: Maximum possible applied voltage.)

- 1-2. Influence of over voltage

Over voltage that is applied to the capacitor may result in an electrical short circuit caused by the breakdown of the internal dielectric layers. The time duration until breakdown depends on the applied voltage and the ambient temperature.
2. Use a safety standard certified capacitor in a power supply input circuit (AC filter), as it is also necessary to consider the withstand voltage and impulse withstand voltage defined for each device.

4. Type of Applied Voltage and Self-heating Temperature

1. Confirm the operating conditions to make sure that no large current is flowing into the capacitor due to the continuous application of an AC voltage or pulse voltage. When a DC rated voltage product is used in an AC voltage circuit or a pulse voltage circuit, the AC current or pulse current will flow into the capacitor; therefore check the self-heating condition. Please confirm the surface temperature of the capacitor so that the temperature remains within the upper limits of the operating temperature, including the rise in temperature due to self-heating. When the capacitor is used with a high-frequency voltage or pulse voltage, heat may be generated by dielectric loss.

<Applicable to Rated Voltage of less than 100VDC>

- 1-1. The load should be contained to the level such that when measuring at atmospheric temperature of 25°C, the product's self-heating remains below 20°C and the surface temperature of the capacitor in the actual circuit remains within the maximum operating temperature.

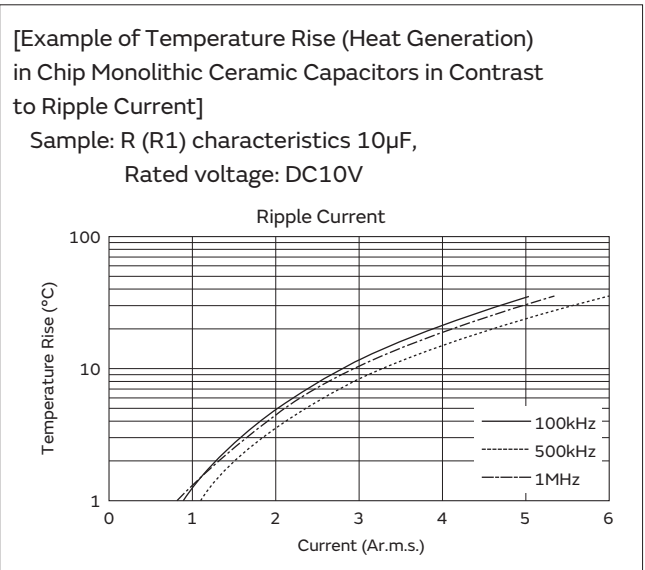



Continued from the preceding page. ↘

<Applicable to Temperature Characteristics X7R (R7), X7T (D7) beyond Rated Voltage of 200VDC>

1-2. The load should be contained so that the self-heating of the capacitor body remains below 20°C, when measuring at an ambient temperature of 25°C. In addition, use a K thermocouple of $\varnothing 0.1\text{mm}$ with less heat capacity when measuring, and measure in a condition where there is no effect from the radiant heat of other components or air flow caused by convection. Excessive generation of heat may cause deterioration of the characteristics and reliability of the capacitor. (Absolutely do not perform measurements while the cooling fan is operating, as an accurate measurement may not be performed.)

<Applicable to Temperature Characteristics U2J (7U), COG (5C) beyond Rated Voltage of 200VDC>

1-3. Since the self-heating is low in the low loss series, the allowable power becomes extremely high compared to the common X7R (R7) characteristics. However, when a load with self-heating of 20°C is applied at the rated voltage, the allowable power may be exceeded. When the capacitor is used in a high-frequency voltage circuit of 1kHz or more, the frequency of the applied voltage should be less than 500kHz sine wave (less than 100kHz for a product with rated voltage of DC3.15kV), to limit the voltage load so that the load remains within the derating shown in the following figure. In the case of non-sine wave, high-frequency components exceeding the fundamental frequency may be included. In such a case, please contact Murata. The excessive generation of heat may cause deterioration of the characteristics and reliability of the capacitor. (Absolutely do not perform measurements while the cooling fan is operating, as an accurate measurement may not be performed.)

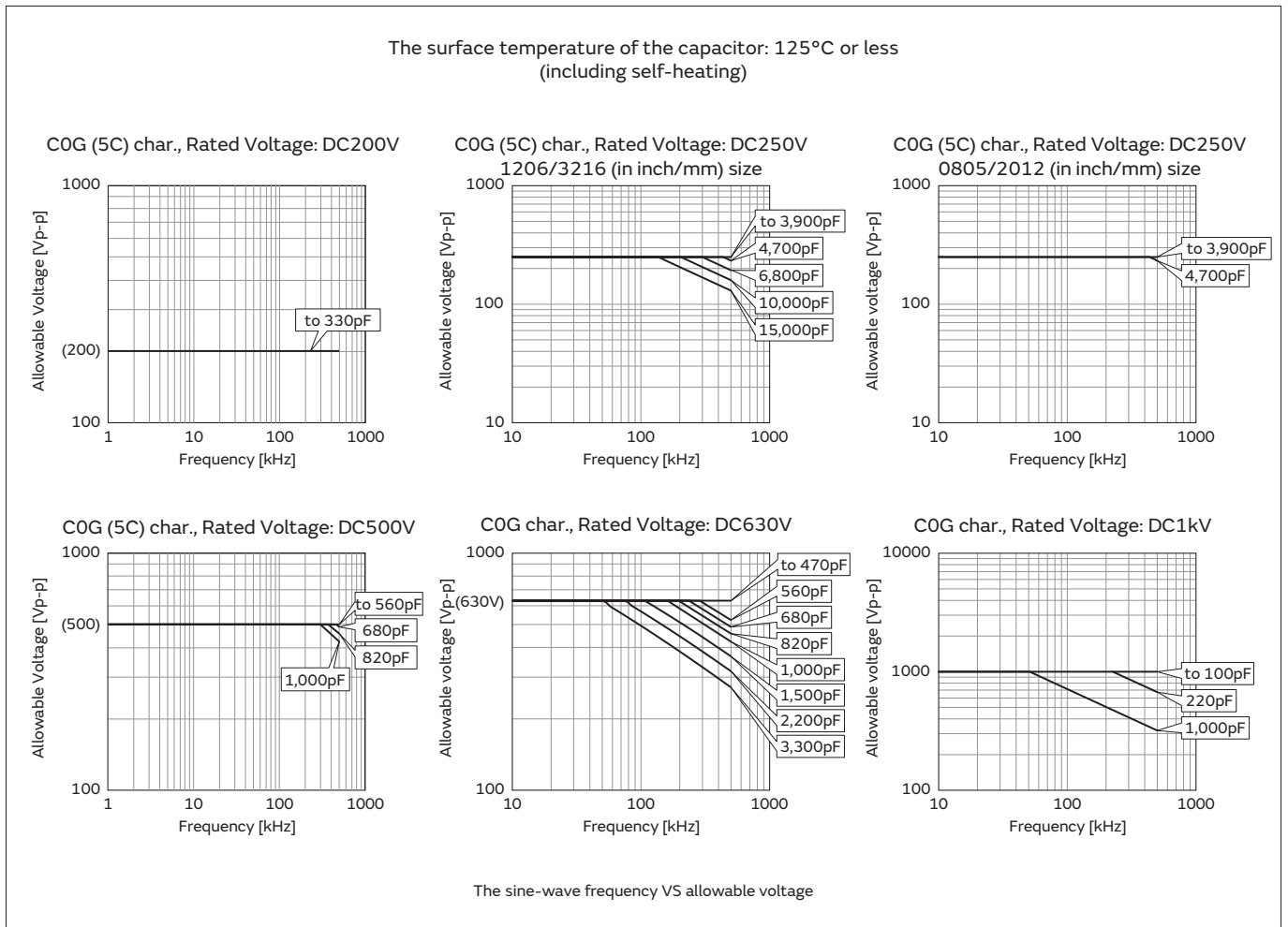

Continued on the following page. ↗

GRM Series
 GJM Series
 GMA Series
 GMD Series
 GOM Series
 GR3 Series
 GRJ Series
 LLA Series
 LLL Series
 LLM Series
 LLR Series
 KRM Series
 KR3 Series
 NFM Series
 GCH Series
 ⚠Caution

⚠Caution

Continued from the preceding page. ↘

The surface temperature of the capacitor: 125°C or less
 (including self-heating)

U2J (7U) char., Rated Voltage: DC200V

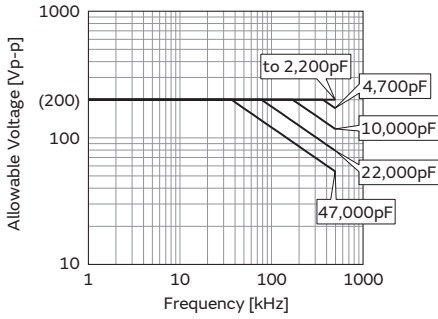

U2J (7U) char., Rated Voltage: DC250V

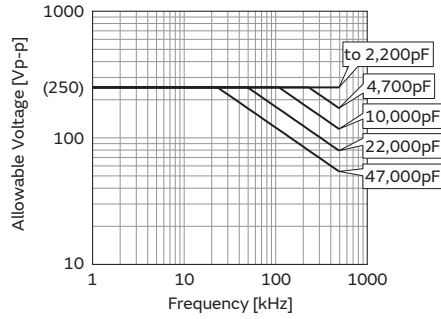

U2J (7U) char., Rated Voltage: DC500V

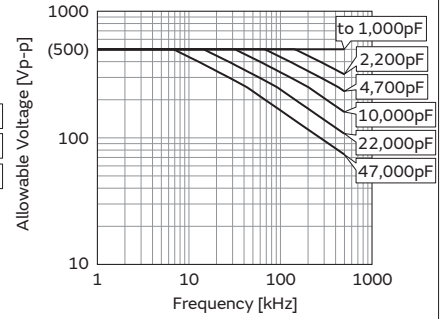

U2J (7U) char., Rated Voltage: DC630V

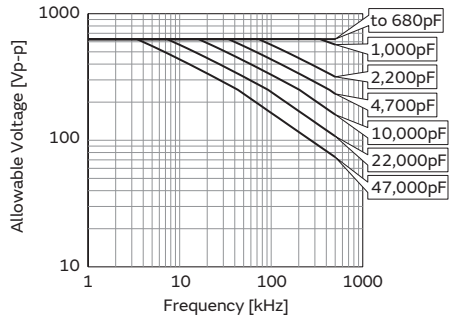

U2J (7U) char., Rated Voltage: DC1kV

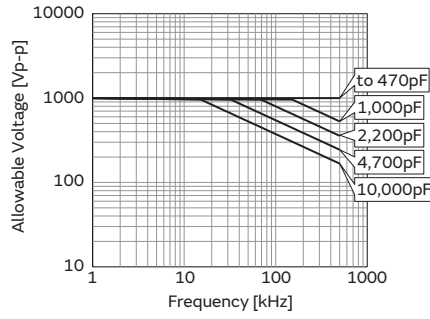

U2J (7U) char., Rated Voltage: DC2kV

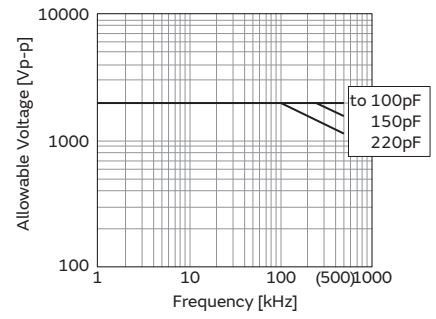

U2J (7U) char., Rated Voltage: DC3.15kV

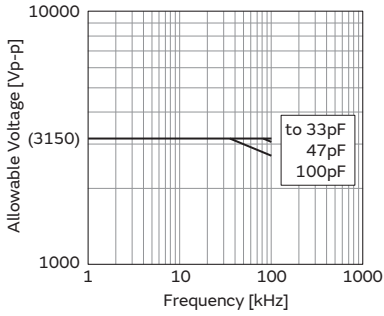

The sine-wave frequency VS allowable voltage

Continued on the following page. ↗

GRM Series
 GJM Series
 GMA Series
 GMD Series
 GQM Series
 GR3 Series
 GRJ Series
 LLA Series
 LLL Series
 LLM Series
 LLR Series
 KRM Series
 KR3 Series
 NFM Series
 GCH Series
 ⚠Caution



Continued from the preceding page. ↘

5. DC Voltage and AC Voltage Characteristics

1. The capacitance value of a high dielectric constant type capacitor changes depending on the DC voltage applied. Please consider the DC voltage characteristics when a capacitor is selected for use in a DC circuit.

1-1. The capacitance of ceramic capacitors may change sharply depending on the applied voltage (see figure). Please confirm the following in order to secure the capacitance.

- (1) Determine whether the capacitance change caused by the applied voltage is within the allowed range.
- (2) In the DC voltage characteristics, the rate of capacitance change becomes larger as voltage increases, even if the applied voltage is below the rated voltage. When a high dielectric constant type capacitor is used in a circuit that requires a tight (narrow) capacitance tolerance (e.g., a time constant circuit), please carefully consider the voltage characteristics, and confirm the various characteristics in the actual operating conditions of the system.

2. The capacitance values of high dielectric constant type capacitors changes depending on the AC voltage applied. Please consider the AC voltage characteristics when selecting a capacitor to be used in an AC circuit.

[Example of DC Voltage Characteristics]
 Sample: X7R (R7) Characteristics 0.1μF,
 Rated Voltage 50VDC

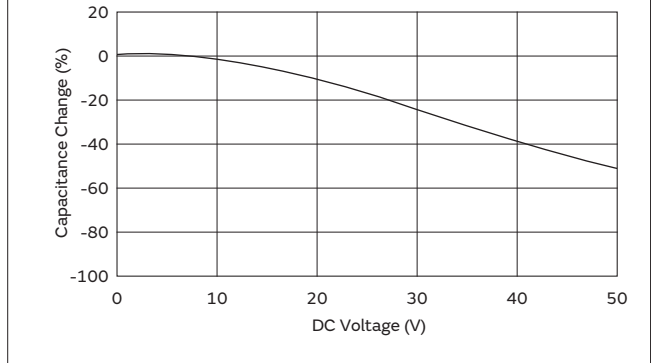

[Example of AC Voltage Characteristics]
 Sample: X7R (R7) Characteristics 10μF,
 Rated Voltage 6.3VDC

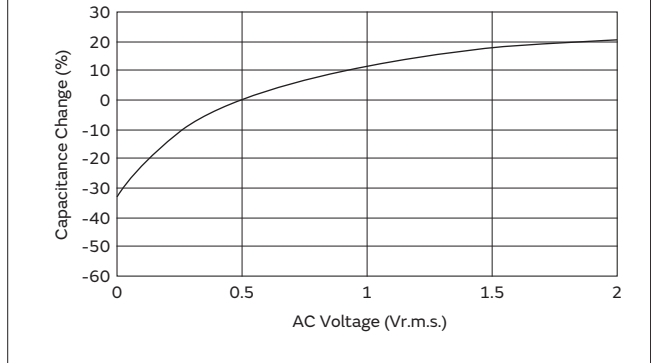

6. Capacitance Aging

1. The high dielectric constant type capacitors have an Aging characteristic in which the capacitance value decreases with the passage of time. When you use high dielectric constant type capacitors in a circuit that needs a tight (narrow) capacitance tolerance (e.g., a time-constant circuit), please carefully consider the characteristics of these capacitors, such as their aging, voltage, and temperature characteristics. In addition, check capacitors using your actual appliances at the intended environment and operating conditions.

[Example of Change Over Time (Aging Characteristics)]

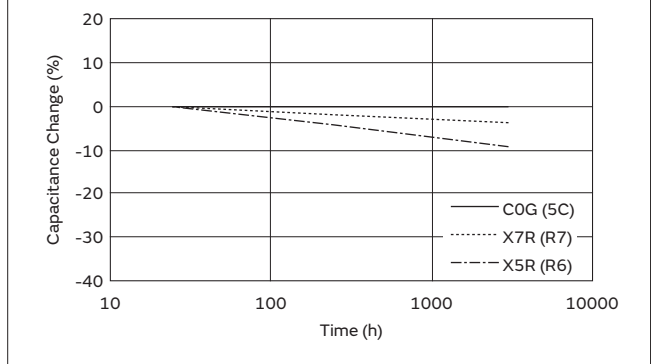

Continued on the following page. ↗

GRM Series
 GJM Series
 GVA Series
 GMD Series
 GOM Series
 GR3 Series
 GRJ Series
 LLA Series
 LLL Series
 LLM Series
 LLR Series
 KRM Series
 KR3 Series
 NFM Series
 GCH Series
 ⚠Caution

⚠Caution

Continued from the preceding page. ↘

7. Vibration and Shock

1. Please confirm the kind of vibration and/or shock, its condition, and any generation of resonance.
 Please mount the capacitor so as not to generate resonance, and do not allow any impact on the terminals.
2. Mechanical shock due to being dropped may cause damage or a crack in the dielectric material of the capacitor.
 Do not use a dropped capacitor because the quality and reliability may be deteriorated.
3. When printed circuit boards are piled up or handled, the corner of another printed circuit board should not be allowed to hit the capacitor, in order to avoid a crack or other damage to the capacitor.

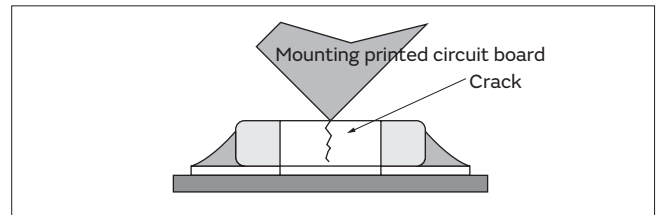
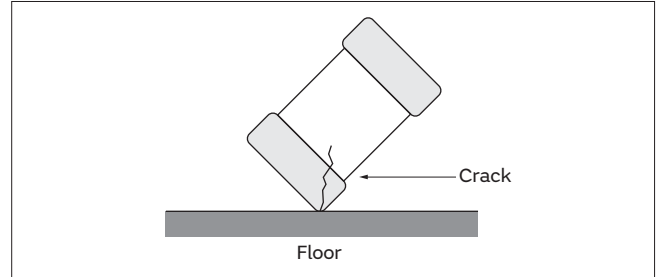

Soldering and Mounting

1. Mounting Position

1. Confirm the best mounting position and direction that minimizes the stress imposed on the capacitor during flexing or bending of the printed circuit board.
 - 1-1. Choose a mounting position that minimizes the stress imposed on the chip during flexing or bending of the board.

[Component Direction]

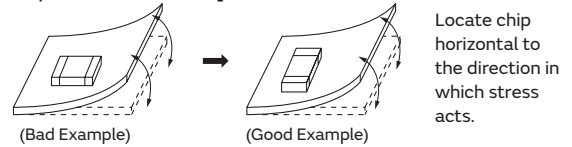

[Chip Mounting Close to Board Separation Point]

It is effective to implement the following measures, to reduce stress in separating the board.

It is best to implement all of the following three measures; however, implement as many measures as possible to reduce stress.

Contents of Measures	Stress Level
(1) Turn the mounting direction of the component parallel to the board separation surface.	A > D *1
(2) Add slits in the board separation part.	A > B
(3) Keep the mounting position of the component away from the board separation surface.	A > C

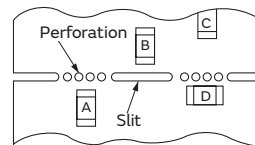

*1 A > D is valid when stress is added vertically to the perforation as with Hand Separation.

If a Cutting Disc is used, stress will be diagonal to the PCB, therefore A > D is invalid.

[Mounting Capacitors Near Screw Holes]

When a capacitor is mounted near a screw hole, it may be affected by the board deflection that occurs during the tightening of the screw. Mount the capacitor in a position as far away from the screw holes as possible.

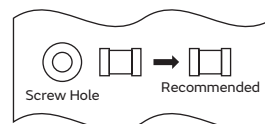

Continued on the following page. ↗



Continued from the preceding page. ↘

2. Information before Mounting

1. Do not re-use capacitors that were removed from the equipment.
2. Confirm capacitance characteristics under actual applied voltage.
3. Confirm the mechanical stress under actual process and equipment use.
4. Confirm the rated capacitance, rated voltage and other electrical characteristics before assembly.
5. Prior to use, confirm the solderability of capacitors that were in long-term storage.
6. Prior to measuring capacitance, carry out a heat treatment for capacitors that were in long-term storage.
7. The use of Sn-Zn based solder will deteriorate the reliability of the MLCC.

Please contact our sales representative or product engineers on the use of Sn-Zn based solder in advance.

8. We have also produced a DVD which shows a summary of our recommendations, regarding the precautions for mounting. Please contact our sales representative to request the DVD.

3. Maintenance of the Mounting (pick and place) Machine

1. Make sure that the following excessive forces are not applied to the capacitors.
 - 1-1. In mounting the capacitors on the printed circuit board, any bending force against them shall be kept to a minimum to prevent them from any damage or cracking. Please take into account the following precautions and recommendations for use in your process.
 - (1) Adjust the lowest position of the pickup nozzle so as not to bend the printed circuit board.
 - (2) Adjust the nozzle pressure within a static load of 1N to 3N during mounting.

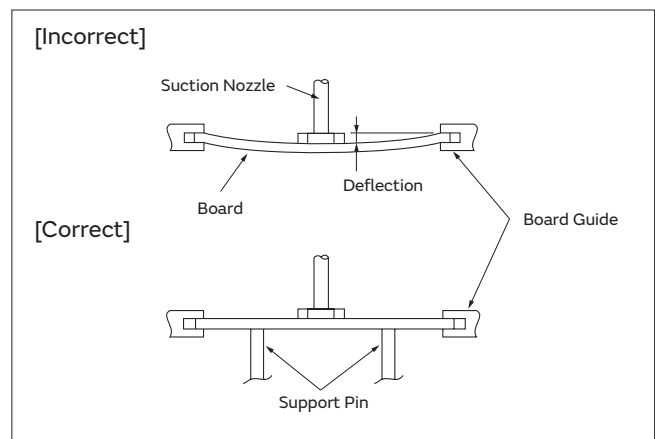

2. Dirt particles and dust accumulated between the suction nozzle and the cylinder inner wall prevent the nozzle from moving smoothly. This imposes greater force upon the chip during mounting, causing cracked chips. Also, the locating claw, when worn out, imposes uneven forces on the chip when positioning, causing cracked chips. The suction nozzle and the locating claw must be maintained, checked, and replaced periodically.

<Applicable to ZRB Series>

3. To adjust the inspection tolerance for automated appearance sorting machine of mounting position, because ZRB series are easier to shift the mounting position than standard MLCC.
4. To check the overturn and reverse of chip.
5. To control mounting speed carefully, because ZRB series is heavier than standard MLCC.

Continued on the following page. ↗

⚠Caution

Continued from the preceding page. ↘

4-1. Reflow Soldering

- When sudden heat is applied to the components, the mechanical strength of the components will decrease because a sudden temperature change causes deformation inside the components. In order to prevent mechanical damage to the components, preheating is required for both the components and the PCB. Preheating conditions are shown in table 1. It is required to keep the temperature differential between the solder and the components surface (ΔT) as small as possible.
- When components are immersed in solvent after mounting, be sure to maintain the temperature difference (ΔT) between the component and the solvent within the range shown in table 1.

Table 1

Series	Chip Dimension Code (L/W)	Temperature Differential
GRM/GJM/GQM/GR3/GRJ/KRM/LLR	02/03/15/18/21/31	$\Delta T \leq 190^\circ\text{C}$
LLL	02/03/15/18/1U/21/31	
ZRB	15/18	
GR3/GRJ/GRM/KR3/KRM	32/43/55	$\Delta T \leq 130^\circ\text{C}$
LLA/LLM	18/21/31	
GQM	22	

Recommended Conditions

	Pb-Sn Solder	Lead Free Solder
Peak Temperature	230 to 250°C	240 to 260°C
Atmosphere	Air	Air or N ₂

Pb-Sn Solder: Sn-37Pb

Lead Free Solder: Sn-3.0Ag-0.5Cu

- When a capacitor is mounted at a temperature lower than the peak reflow temperature recommended by the solder manufacturer, the following quality problems can occur. Consider factors such as the placement of peripheral components and the reflow temperature setting to prevent the capacitor's reflow temperature from dropping below the peak temperature specified. Be sure to evaluate the mounting situation beforehand and verify that none of the following problems occur.
 - Drop in solder wettability
 - Solder voids
 - Possible occurrence of whiskering
 - Drop in bonding strength
 - Drop in self-alignment properties
 - Possible occurrence of tombstones and/or shifting on the land patterns of the circuit board

Inverting the PCB

Make sure not to impose any abnormal mechanical shocks to the PCB.

[Standard Conditions for Reflow Soldering]

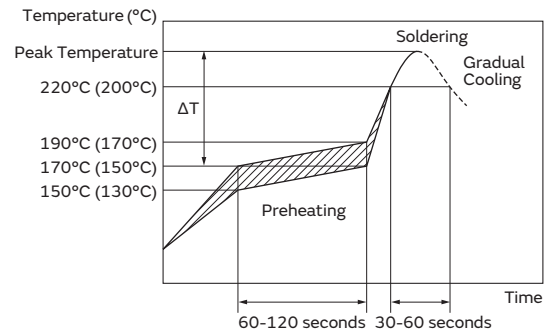

Temperature
 Incase of Lead Free Solder
 (): In case of Pb-Sn Solder

[Allowable Reflow Soldering Temperature and Time]

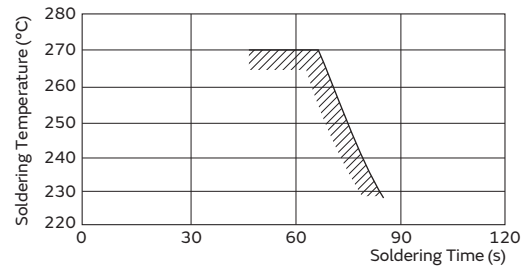

In the case of repeated soldering, the accumulated soldering time must be within the range shown above.

4. Optimum Solder Amount for Reflow Soldering

- Overly thick application of solder paste results in an excessive solder fillet height. This makes the chip more susceptible to mechanical and thermal stress on the board and may cause the chips to crack.
- Too little solder paste results in a lack of adhesive strength on the termination, which may result in chips breaking loose from the PCB.
- Please confirm that solder has been applied smoothly to the termination.

Continued on the following page. ↗



Continued from the preceding page. ↘

4-2. Flow Soldering

1. Do not apply flow soldering to chips not listed in table 2.

Table 2

Series	Chip Dimension Code (L/W)	Temperature Differential
GR3/GRM	18/21/31	$\Delta T \leq 150^{\circ}\text{C}$
GQM	18/21	
LLL	21/31	
GRJ	18/21/31	

- When sudden heat is applied to the components, the mechanical strength of the components will decrease because a sudden temperature change causes deformation inside the components. In order to prevent mechanical damage to the components, preheating is required for both of the components and the PCB. Preheating conditions are shown in table 2. It is required to keep the temperature differential between the solder and the components surface (ΔT) as low as possible.
- Excessively long soldering time or high soldering temperature can result in leaching of the terminations, causing poor adhesion or a reduction in capacitance value due to loss of contact between the inner electrodes and terminations.
- When components are immersed in solvent after mounting, be sure to maintain the temperature differential (ΔT) between the component and solvent within the range shown in the table 2.

Recommended Conditions

	Pb-Sn Solder	Lead Free Solder
Preheating Peak Temperature	90 to 110°C	100 to 120°C
Soldering Peak Temperature	240 to 250°C	250 to 260°C
Atmosphere	Air	Air or N ₂

Pb-Sn Solder: Sn-37Pb

Lead Free Solder: Sn-3.0Ag-0.5Cu

5. Optimum Solder Amount for Flow Soldering

- The top of the solder fillet should be lower than the thickness of the components. If the solder amount is excessive, the risk of cracking is higher during board bending or any other stressful condition.

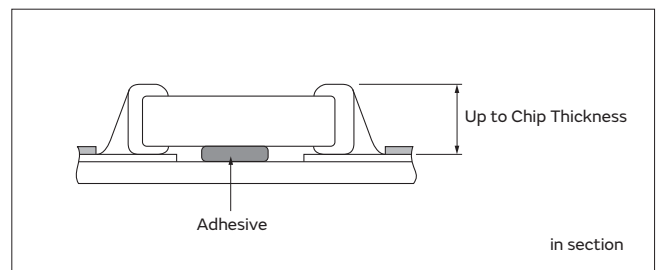
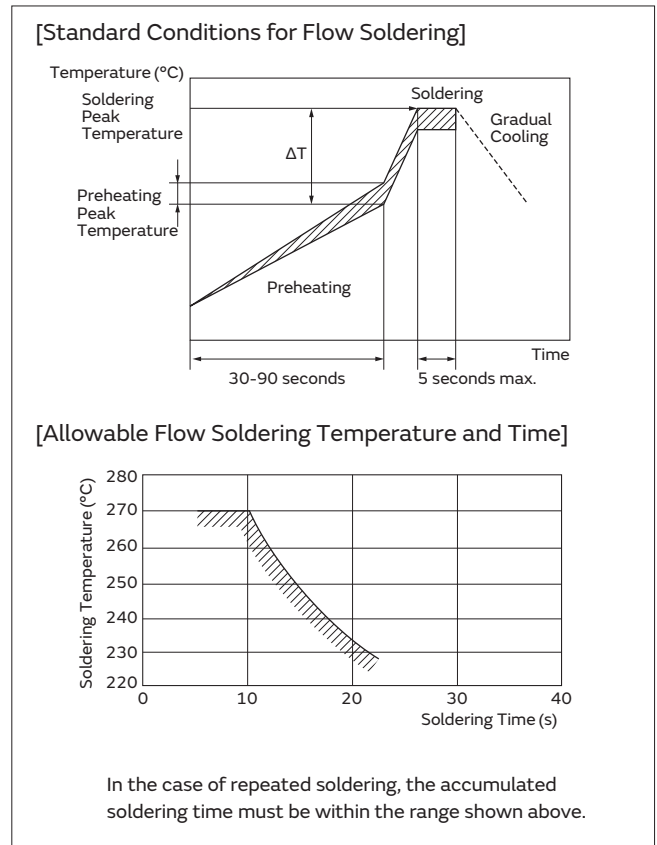

Continued on the following page. ↗

GRM Series

GJM Series

GVA Series

GMD Series

GQM Series

GR3 Series

GRJ Series

LLA Series

LLL Series

LLM Series

LLR Series

KRM Series

KR3 Series

NFM Series

GCH Series

⚠Caution

⚠Caution

Continued from the preceding page. ↘

4-3. Correction of Soldered Portion

When sudden heat is applied to the capacitor, distortion caused by the large temperature difference occurs internally, and can be the cause of cracks. Capacitors also tend to be affected by mechanical and thermal stress depending on the board preheating temperature or the soldering fillet shape, and can be the cause of cracks. Please refer to "1. PCB Design" or "3. Optimum solder amount" for the solder amount and the fillet shapes.

Do not correct with a soldering iron for ZRB series.
 Correction with a soldering iron for ZRB series may cause loss suppress acoustic noise, because the solder amount become excessive.

1. Correction with a Soldering Iron

- 1-1. In order to reduce damage to the capacitor, be sure to preheat the capacitor and the mounting board. Preheat to the temperature range shown in Table 3. A hot plate, hot air type preheater, etc. can be used for preheating.
- 1-2. After soldering, do not allow the component/PCB to cool down rapidly.
- 1-3. Perform the corrections with a soldering iron as quickly as possible. If the soldering iron is applied too long, there is a possibility of causing solder leaching on the terminal electrodes, which will cause deterioration of the adhesive strength and other problems.

Table 3

Series	Chip Dimension Code (L/W)	Temperature of Soldering Iron Tip	Preheating Temperature	Temperature Differential (ΔT)	Atmosphere
GJM/GQM/GR3/GRJ/GRM	03/15/18/21/31	350°C max.	150°C min.	ΔT≤190°C	Air
GRJ/GRM	32/43/55	280°C max.	150°C min.	ΔT≤130°C	Air
GQM	22				

*Applicable for both Pb-Sn and Lead Free Solder.
 Pb-Sn Solder: Sn-37Pb
 Lead Free Solder: Sn-3.0Ag-0.5Cu
 *Please manage ΔT in the temperature of soldering iron and the preheating temperature.

2. Correction with Spot Heater

Compared to local heating with a soldering iron, hot air heating by a spot heater heats the overall component and board, therefore, it tends to lessen the thermal shock. In the case of a high density mounted board, a spot heater can also prevent concerns of the soldering iron making direct contact with the component.

2-1. If the distance from the hot air outlet of the spot heater to the component is too close, cracks may occur due to thermal shock. To prevent this problem, follow the conditions shown in Table 4.

2-2. In order to create an appropriate solder fillet shape, it is recommended that hot air be applied at the angle shown in Figure 1.

Table 4

Distance	5mm or more
Hot Air Application Angle	45° *Figure 1
Hot Air Temperature Nozzle Outlet	400°C max.
Application Time	Less than 10 seconds (1206 (3216 in mm) size or smaller)
	Less than 30 seconds (1210 (3225 in mm) size or larger)

[Figure 1]

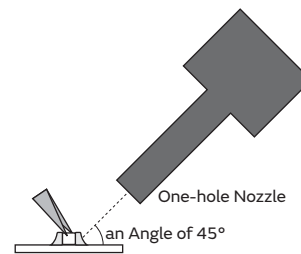

3. Optimum solder amount when re-working with a soldering iron

3-1. If the solder amount is excessive, the risk of cracking is higher during board bending or any other stressful condition.

Too little solder amount results in a lack of adhesive strength on the termination, which may result in chips breaking loose from the PCB.

Please confirm that solder has been applied smoothly and rising to the end surface of the chip.

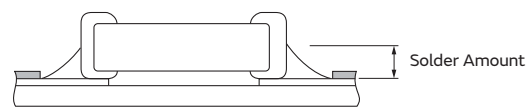

in section

Continued on the following page. ↗

⚠Caution

Continued from the preceding page. ↘

3-2. A soldering iron with a tip of $\varnothing 3\text{mm}$ or smaller should be used. It is also necessary to keep the soldering iron from touching the components during the re-work.

3-3. Solder wire with $\varnothing 0.5\text{mm}$ or smaller is required for soldering.

<Applicable to KR3/KRM Series>

4. For the shape of the soldering iron tip, refer to the figure on the right.

Regarding the type of solder, use a wire diameter of $\varnothing 0.5\text{mm}$ or less (rosin core wire solder).

4-1. How to Apply the Soldering Iron

Apply the tip of the soldering iron against the lower end of the metal terminal.

- 1) In order to prevent cracking caused by sudden heating of the ceramic device, do not touch the ceramic base directly.
- 2) In order to prevent deviations and dislocating of the chip, do not touch the junction of the chip and the metal terminal, and the metal portion on the outside directly.

4-2. Appropriate Amount of Solder

The amount of solder for corrections by soldering iron, should be lower than the height of the lower side of the chip.

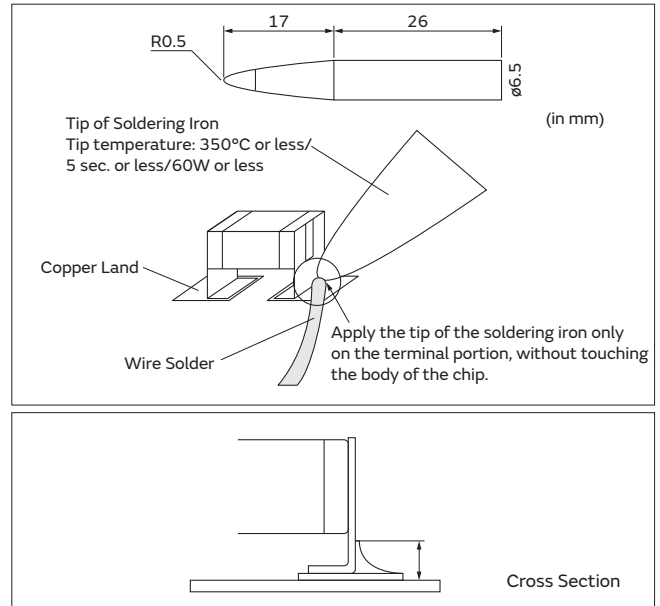

5. Washing

Excessive ultrasonic oscillation during cleaning can cause the PCBs to resonate, resulting in cracked chips or broken solder joints. Take note not to vibrate PCBs.

6. Electrical Test on Printed Circuit Board

1. Confirm position of the support pin or specific jig, when inspecting the electrical performance of a capacitor after mounting on the printed circuit board.

1-1. Avoid bending the printed circuit board by the pressure of a test-probe, etc.

The thrusting force of the test probe can flex the PCB, resulting in cracked chips or open solder joints.

Provide support pins on the back side of the PCB to prevent warping or flexing. Install support pins as close to the test-probe as possible.

1-2. Avoid vibration of the board by shock when a test-probe contacts a printed circuit board.

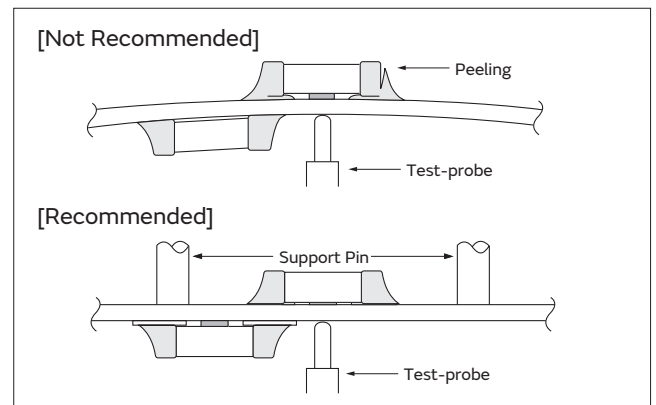

7. Printed Circuit Board Cropping

1. After mounting a capacitor on a printed circuit board, do not apply any stress to the capacitor that causes bending or twisting the board.

1-1. In cropping the board, the stress as shown at right may cause the capacitor to crack.

Cracked capacitors may cause deterioration of the insulation resistance, and result in a short.

Avoid this type of stress to a capacitor.

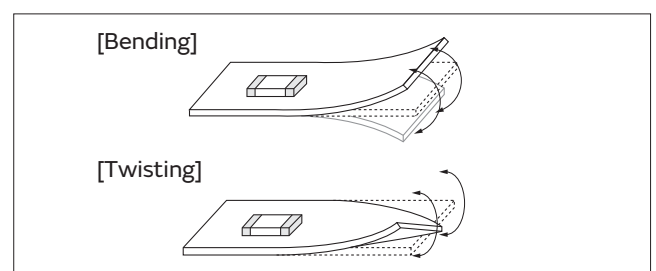

Continued on the following page. ↗

△Caution

Continued from the preceding page. ↘

2. Check the cropping method for the printed circuit board in advance.

2-1. Printed circuit board cropping shall be carried out by using a jig or an apparatus (Disc separator, router type separator, etc.) to prevent the mechanical stress that can occur to the board.

Board Separation Method	Hand Separation Nipper Separation	(1) Board Separation Jig	Board Separation Apparatus	
			(2) Disc Separator	(3) Router Type Separator
Level of stress on board	High	Medium	Medium	Low
Recommended	×	△*	△*	○
Notes	Hand and nipper separation apply a high level of stress. Use another method.	<ul style="list-style-type: none"> Board handling Board bending direction Layout of capacitors 	<ul style="list-style-type: none"> Board handling Layout of slits Design of V groove Arrangement of blades Controlling blade life 	Board handling

* When a board separation jig or disc separator is used, if the following precautions are not observed, a large board deflection stress will occur and the capacitors may crack. Use router type separator if at all possible.

(1) Example of a suitable jig

[In the case of Single-side Mounting]

An outline of the board separation jig is shown as follows. Recommended example: Stress on the component mounting position can be minimized by holding the portion close to the jig, and bend in the direction towards the side where the capacitors are mounted. Not recommended example: The risk of cracks occurring in the capacitors increases due to large stress being applied to the component mounting position, if the portion away from the jig is held and bent in the direction opposite the side where the capacitors are mounted.

[Outline of Jig]

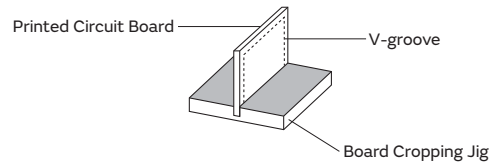

Hand Separation

Recommended	Not Recommended

[In the case of Double-sided Mounting]

Since components are mounted on both sides of the board, the risk of cracks occurring can not be avoided with the above method. Therefore, implement the following measures to prevent stress from being applied to the components.

(Measures)

- Consider introducing a router type separator. If it is difficult to introduce a router type separator, implement the following measures. (Refer to item 1. Mounting Position)
- Mount the components parallel to the board separation surface.
- When mounting components near the board separation point, add slits in the separation position near the component.
- Keep the mounting position of the components away from the board separation point.

Continued on the following page. ↗



Continued from the preceding page. ↘

(2) Example of a Disc Separator

An outline of a disc separator is shown as follows. As shown in the Principle of Operation, the top blade and bottom blade are aligned with the V-grooves on the printed circuit board to separate the board.

In the following case, board deflection stress will be applied and cause cracks in the capacitors.

- (1) When the adjustment of the top and bottom blades are misaligned, such as deviating in the top-bottom, left-right or front-rear directions
- (2) The angle of the V groove is too low, depth of the V groove is too shallow, or the V groove is misaligned top-bottom

IF V groove is too deep, it is possible to brake when you handle and carry it. Carefully design depth of the V groove with consideration about strength of material of the printed circuit board.

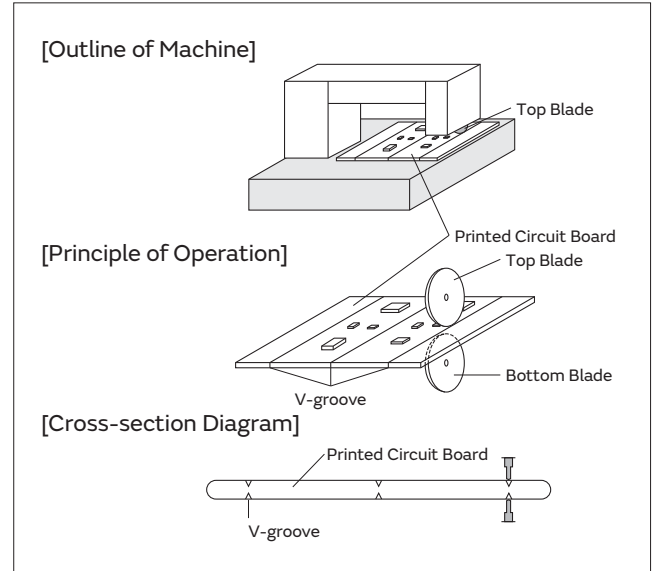

Disc Separator

Recommended	Not Recommended		
	Top-bottom Misalignment	Left-right Misalignment	Front-rear Misalignment
<p>Top Blade</p> <p>Bottom Blade</p>	<p>Top Blade</p> <p>Bottom Blade</p>	<p>Top Blade</p> <p>Bottom Blade</p>	<p>Top Blade</p> <p>Bottom Blade</p>

V-groove Design

Example of Recommended V-groove Design	Not Recommended			
	Left-right Misalignment	Low-Angle	Depth too Shallow	Depth too Deep

(3) Example of Router Type Separator

The router type separator performs cutting by a router rotating at a high speed. Since the board does not bend in the cutting process, stress on the board can be suppressed during board separation.

When attaching or removing boards to/from the router type separator, carefully handle the boards to prevent bending.

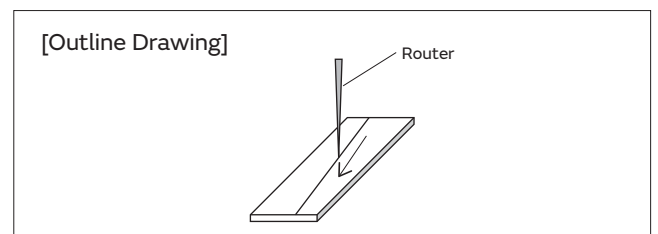

Continued on the following page. ↗

GRM Series
 GJM Series
 GMA Series
 GMD Series
 GOM Series
 GR3 Series
 GRJ Series
 LLA Series
 LLL Series
 LLM Series
 LLR Series
 KRM Series
 KR3 Series
 NFM Series
 GCH Series
 ⚠Caution

GRM Series
 GJM Series
 GMA Series
 GMD Series
 GQM Series
 GR3 Series
 GRJ Series
 LLA Series
 LLL Series
 LLM Series
 LLR Series
 KRM Series
 KR3 Series
 NFM Series
 GCH Series
 ⚠Caution

⚠Caution

Continued from the preceding page. ↘

8. Assembly

1. Handling

If a board mounted with capacitors is held with one hand, the board may bend. Firmly hold the edges of the board with both hands when handling.

If a board mounted with capacitors is dropped, cracks may occur in the capacitors.

Do not use dropped boards, as there is a possibility that the quality of the capacitors may be impaired.

2. Attachment of Other Components

2-1. Mounting of Other Components

Pay attention to the following items, when mounting other components on the back side of the board after capacitors have been mounted on the opposite side.

When the bottom dead point of the suction nozzle is set too low, board deflection stress may be applied to the capacitors on the back side (bottom side), and cracks may occur in the capacitors.

- After the board is straightened, set the bottom dead point of the nozzle on the upper surface of the board.
- Periodically check and adjust the bottom dead point.

2-2. Inserting Components with Leads into Boards

When inserting components (transformers, IC, etc.) into boards, bending the board may cause cracks in the capacitors or cracks in the solder.

Pay attention to the following.

- Increase the size of the holes to insert the leads, to reduce the stress on the board during insertion.
- Fix the board with support pins or a dedicated jig before insertion.
- Support below the board so that the board does not bend. When using multiple support pins on the board, periodically confirm that there is no difference in the height of each support pin.

2-3. Attaching/Removing Sockets

When the board itself is a connector, the board may bend when a socket is attached or removed. Plan the work so that the board does not bend when a socket is attached or removed.

2-4. Tightening Screws

The board may be bent, when tightening screws, etc. during the attachment of the board to a shield or chassis.

Pay attention to the following items before performing the work.

- Plan the work to prevent the board from bending.
- Use a torque screwdriver, to prevent over-tightening of the screws.
- The board may bend after mounting by reflow soldering, etc. Please note, as stress may be applied to the chips by forcibly flattening the board when tightening the screws.

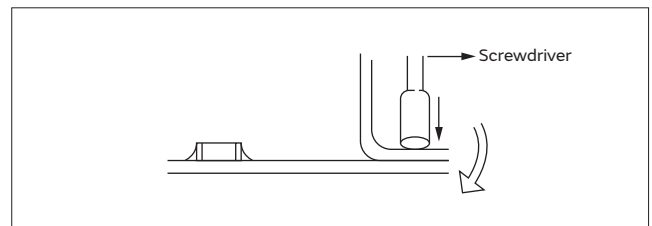
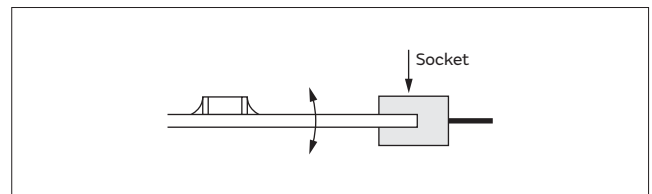
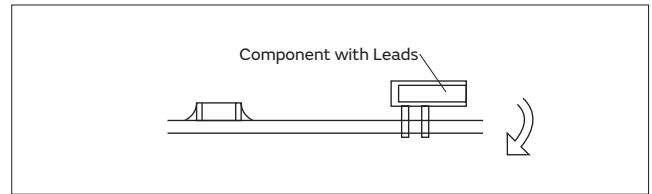
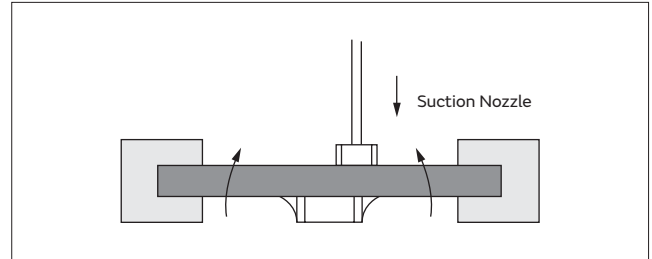

Continued on the following page. ↗



Continued from the preceding page. ↘

<Applicable to GMA or GMD Series>

9. Die Bonding/Wire Bonding

1. Die Bonding of Capacitors

- 1-1. Use the following materials for the Brazing alloys:
Au-Sn (80/20) 300 to 320 °C in N₂ atmosphere
- 1-2. Mounting
 - (1) Control the temperature of the substrate so it matches the temperature of the brazing alloy.
 - (2) Place the brazing alloy on the substrate and place the capacitor on the alloy. Hold the capacitor and gently apply the load. Be sure to complete the operation within 1 minute.

2. Wire Bonding

- 2-1. Wire
Gold wire: 25 micro m (0.001 inch) diameter
- 2-2. Bonding
 - (1) Thermo compression, ultrasonic ball bonding.
 - (2) Required stage temperature: 150 to 200 °C
 - (3) Required wedge or capillary weight: 0.2N to 0.5N
 - (4) Bond the capacitor and base substrate or other devices with gold wire.

Other

1. Under Operation of Equipment

- 1-1. Do not touch a capacitor directly with bare hands during operation in order to avoid the danger of an electric shock.
- 1-2. Do not allow the terminals of a capacitor to come in contact with any conductive objects (short-circuit). Do not expose a capacitor to a conductive liquid, including any acid or alkali solutions.
- 1-3. Confirm the environment in which the equipment will operate is under the specified conditions. Do not use the equipment under the following environments.
 - (1) Being splattered with water or oil.
 - (2) Being exposed to direct sunlight.
 - (3) Being exposed to ozone, ultraviolet rays, or radiation.
 - (4) Being exposed to toxic gas (e.g., hydrogen sulfide, sulfur dioxide, chlorine, ammonia gas, etc.)
 - (5) Any vibrations or mechanical shocks exceeding the specified limits.
 - (6) Moisture condensing environments.
- 1-4. Use damp proof countermeasures if using under any conditions that can cause condensation.

2. Other

- 2-1. In an Emergency
 - (1) If the equipment should generate smoke, fire, or smell, immediately turn off or unplug the equipment.
If the equipment is not turned off or unplugged, the hazards may be worsened by supplying continuous power.
 - (2) In this type of situation, do not allow face and hands to come in contact with the capacitor or burns may be caused by the capacitor's high temperature.

2-2. Disposal of Waste

When capacitors are disposed of, they must be burned or buried by an industrial waste vendor with the appropriate licenses.

2-3. Circuit Design

- (1) Addition of Fail Safe Function
Capacitors that are cracked by dropping or bending of the board may cause deterioration of the insulation resistance, and result in a short. If the circuit being used may cause an electrical shock, smoke or fire when a capacitor is shorted, be sure to install fail-safe functions, such as a fuse, to prevent secondary accidents.
- (2) Capacitors used to prevent electromagnetic interference in the primary AC side circuit, or as a connection/insulation, must be a safety standard certified product, or satisfy the contents stipulated in the Electrical Appliance and Material Safety Law. Install a fuse for each line in case of a short.
- (3) The GJM, GMA, GMD, GQM, GR3, GRJ, GRM, KR3, KRM, LLA, LLL, LLM, LLR and ZRB series are not safety standard certified products.

2-4. Remarks

Failure to follow the cautions may result, worst case, in a short circuit and smoking when the product is used.

The above notices are for standard applications and conditions. Contact us when the products are used in special mounting conditions.

Select optimum conditions for operation as they determine the reliability of the product after assembly.

The data herein are given in typical values, not guaranteed ratings.

GRM Series

GJM Series

GMA Series

GMD Series

GQM Series

GR3 Series

GRJ Series

LLA Series

LLL Series

LLM Series

LLR Series

KRM Series

KR3 Series

NFM Series

GCH Series

⚠Caution

Notice

Rating

1. Operating Temperature

1. The operating temperature limit depends on the capacitor.

1-1. Do not apply temperatures exceeding the maximum operating temperature.

It is necessary to select a capacitor with a suitable rated temperature that will cover the operating temperature range.

It is also necessary to consider the temperature distribution in equipment and the seasonal temperature variable factor.

1-2. Consider the self-heating factor of the capacitor.

The surface temperature of the capacitor shall not exceed the maximum operating temperature including self-heating.

2. Atmosphere Surroundings (gaseous and liquid)

1. Restriction on the operating environment of capacitors.

1-1. Capacitors, when used in the above, unsuitable,

operating environments may deteriorate due to the corrosion of the terminations and the penetration of moisture into the capacitor.

1-2. The same phenomenon as the above may occur when the electrodes or terminals of the capacitor are subject to moisture condensation.

1-3. The deterioration of characteristics and insulation resistance due to the oxidization or corrosion of terminal electrodes may result in breakdown when the capacitor is exposed to corrosive or volatile gases or solvents for long periods of time.

3. Piezo-electric Phenomenon

1. When using high dielectric constant type capacitors in AC or pulse circuits, the capacitor itself vibrates at specific frequencies and noise may be generated.

Moreover, when the mechanical vibration or shock is added to the capacitor, noise may occur.

Soldering and Mounting

1. PCB Design

1. Notice for Pattern Forms

1-1. Unlike leaded components, chip components are susceptible to flexing stresses since they are mounted directly on the substrate.

They are also more sensitive to mechanical and thermal stresses than leaded components.

Excess solder fillet height can multiply these stresses and cause chip cracking. When designing substrates, take land patterns and dimensions into consideration to eliminate the possibility of excess solder fillet height.

1-2. There is a possibility of chip cracking caused by PCB expansion/contraction with heat, because stress on a chip is different depending on PCB material and structure. When the thermal expansion coefficient greatly differs between the board used for mounting and the chip, it will cause cracking of the chip due to the thermal expansion and contraction.

When capacitors are mounted on a fluorine resin printed circuit board or on a single-layered glass epoxy board, it may also cause cracking of the chip for the same reason.

Pattern Forms

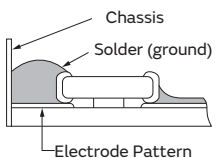
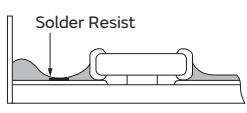
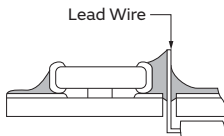
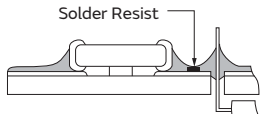
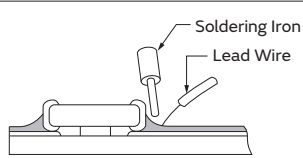
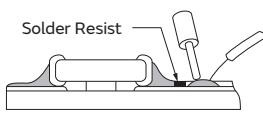
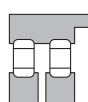
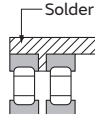
	Prohibited	Correct
Placing Close to Chassis		
Placing of Chip Components and Leaded Components		
Placing of Leaded Components after Chip Component		
Lateral Mounting		

Continued on the following page. ↗

GRM Series
 GJM Series
 GMA Series
 GMD Series
 GQM Series
 GR3 Series
 GRJ Series
 LLA Series
 LLL Series
 LLM Series
 LLR Series
 KRM Series
 KR3 Series
 NFM Series
 GCH Series
 Notice

Notice

Continued from the preceding page. ↘

2. Land Dimensions

2-1. Chip capacitors can be cracked due to the stress of PCB bending, etc. if the land area is larger than needed and has an excess amount of solder.

Please refer to the land dimensions in table 1 for flow soldering, table 2 for reflow soldering, table 3 for reflow soldering for ZRB Series, table 4 for reflow soldering for LLA Series, table 5 for reflow soldering for LLM Series.

Please confirm the suitable land dimension by evaluating of the actual SET / PCB.

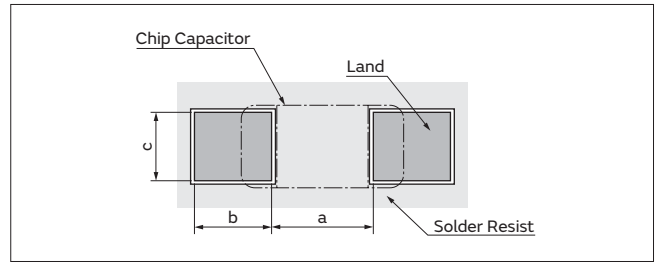

Table 1 Flow Soldering Method

Series	Chip Dimension Code (L/W)	Chip (L×W)	a	b	c
GQM/GR3/GRJ/GRM	18	1.6×0.8	0.6 to 1.0	0.8 to 0.9	0.6 to 0.8
GQM/GR3/GRJ/GRM	21	2.0×1.25	1.0 to 1.2	0.9 to 1.0	0.8 to 1.1
GR3/GRJ/GRM	31	3.2×1.6	2.2 to 2.6	1.0 to 1.1	1.0 to 1.4
LLL	21	1.25×2.0	0.4 to 0.7	0.5 to 0.7	1.4 to 1.8
LLL	31	1.6×3.2	0.6 to 1.0	0.8 to 0.9	2.6 to 2.8

Flow soldering can only be used for products with a chip size from 1.6x0.8mm to 3.2x1.6mm.

(in mm)

Table 2 Reflow Soldering Method

Series	Chip Dimension Code (L/W)	Chip (L×W)	a	b	c
GJM/GRM	02	0.4×0.2	0.16 to 0.2	0.12 to 0.18	0.2 to 0.23
GJM/GRM	03	0.6×0.3 (±0.03)	0.2 to 0.25	0.2 to 0.3	0.25 to 0.35
		0.6×0.3 (±0.05)	0.2 to 0.25	0.25 to 0.35	0.3 to 0.4
		0.6×0.3 (±0.09)	0.23 to 0.3	0.25 to 0.35	0.3 to 0.4
GJM/GRM	15	1.0×0.5 (within ±0.10)	0.3 to 0.5	0.35 to 0.45	0.4 to 0.6
		1.0×0.5 (±0.15/±0.20)	0.4 to 0.6	0.4 to 0.5	0.5 to 0.7
GQM/GR3/GRJ/GRM	18	1.6×0.8 (within ±0.10)	0.6 to 0.8	0.6 to 0.7	0.6 to 0.8
		1.6×0.8 (±0.15/±0.20)	0.7 to 0.9	0.7 to 0.8	0.8 to 1.0
GQM	21	2.0×1.25	1.0 to 1.2	0.6 to 0.7	0.8 to 1.1
GR3/GRJ/GRM	21	2.0×1.25 (within ±0.10)	1.2	0.6	1.25
		2.0×1.25 (±0.15)	1.2	0.6 to 0.8	1.2 to 1.4
		2.0×1.25 (±0.20)	1.0 to 1.4	0.6 to 0.8	1.2 to 1.4
GR3/GRJ/GRM	31	3.2×1.6 (within ±0.20)	1.8 to 2.0	0.9 to 1.2	1.5 to 1.7
		3.2×1.6 (±0.30)	1.9 to 2.1	1.0 to 1.3	1.7 to 1.9
GR3/GRJ/GRM	32	3.2×2.5	2.0 to 2.4	1.0 to 1.2	1.8 to 2.3
GR3/GRJ/GRM	43	4.5×3.2	3.0 to 3.5	1.2 to 1.4	2.3 to 3.0
GR3/GRJ/GRM	55	5.7×5.0	4.0 to 4.6	1.4 to 1.6	3.5 to 4.8
LLL	15	0.5×1.0	0.15 to 0.2	0.2 to 0.25	0.7 to 1.0
LLL	1U	0.6×1.0	0.20 to 0.25	0.25 to 0.35	0.7 to 1.0
LLL/LLR	18	0.8×1.6	0.2 to 0.3	0.3 to 0.4	1.4 to 1.6
LLL	21	1.25×2.0	0.4 to 0.5	0.4 to 0.5	1.4 to 1.8
LLL	31	1.6×3.2	0.6 to 0.8	0.6 to 0.7	2.6 to 2.8
GQM	22	2.8×2.8	2.2 to 2.5	0.8 to 1.0	1.9 to 2.3

(in mm)

<Applicable to Part Number KR3/KRM>

Series	Chip Dimension Code (L/W)	Chip (L×W)	a	b	c
KRM	21	2.0×1.25	1.0 to 1.2	0.6 to 0.7	0.8 to 1.1
KRM	31	3.2×1.6	2.2 to 2.4	0.8 to 0.9	1.0 to 1.4
KR3/KRM	55	5.7×5.0	2.6	2.7	5.6

(in mm)

Continued on the following page. ↗